



OPTIMAL DESIGN OF MAGNETO-RHEOLOGICAL DAMPERS

M. Mohebbi^{*,†} and A. Bagherkhani

Faculty of Engineering, University of Mohaghegh Ardabili, 56199-11367, Ardabil, Iran

ABSTRACT

In the area of semi-active control of civil structures, Magneto-Rheological (MR) damper has been an efficient mechanism for reducing the seismic response of structures. In this paper, an effective method based on defining an optimization problem for designing MR dampers has been proposed. In the proposed method, the parameters of semi-active control system are determined so that the maximum response of structure is minimized. To solve the optimization problem, the Genetic algorithm (GA) has been utilized. The modified Bouc-Wen model has been used to represent the dynamic behavior of MR damper while to determine the input voltage at any time step, the clipped optimal control algorithm with LQR controller has been applied. To evaluate the performance of the proposed method, a ten-storey shear frame subjected to the El-Centro excitation and for two different kinds of objective functions, optimal MR dampers have been designed. Then the performance of optimal MR damper has been tested under different excitations. The results of the numerical simulations have shown the effectiveness of the proposed method in designing optimal MR dampers that have the capability of reducing the response of the structures up to a significant level. In addition, the effect of selecting a proper objective function to achieve the best performance of MR dampers in decreasing different responses of structure has been shown.

Received: 12 June 2014; Accepted: 20 September 2014?

KEY WORDS: semi-active control; MR damper; optimal design; genetic algorithm; clipped optimal control algorithm.

1. INTRODUCTION

In the traditional approach of structure design procedure, structures are designed to resist

*Corresponding author: Faculty of Engineering, University of Mohaghegh Ardabili, 56199-11367, Ardabil, Iran

†E-mail address: mohebbi@uma.ac.ir (M. Mohebbi)

against lateral loads such as wind and earthquake by producing the required strength and ductility. In the new approach, to increase the safety and maintenance of buildings the technology of seismic control of structures has been suggested that provides new ways to protect structures against natural hazards.

In the seismic control of structures field, semi-active control mechanism can be defined as a system that called adjustable passive control system and mostly needs a very small external power source to run where the control force is generated based on the feedback obtained from sensors. In fact, the semi-active control systems have the features of active control systems (ability to adapt to loading conditions) and of passive control systems (absorbing or dissipating the force) together. Therefore semi-active control mechanisms are very efficient in reducing the power consumption and reliable in dissipating the input vibration [1]. Dampers with controllable fluid are examples of semi-active control mechanisms where the viscosity of the fluid within the damper is changeable and it causes the hardness and yielding strength to be changed during the time.

Magneto-Rheological damper is categorized as the subgroup of dampers with controllable fluid and often use MR smart fluid that generally consists of micron particles suspended in a viscous fluid. When the MR fluid is exposed to a magnetic field, the particles in the fluid polarized and the fluid shows visco-plasticity, this causes resistance to flow. Under the magnetic field, the fluid is changed from a linear viscous fluid with a free flow into a semi-solid material, within a few milliseconds [2]. By changing the magnetic field intensity using an algorithm, the control force generated by MR damper can be adjusted correspondingly.

Several studies have been conducted by researchers in order to understand and develop the potential of MR dampers in reducing vibrations due to wind and earthquake which include evaluating the performance of dampers in reducing the seismic responses, developing control algorithms and suggesting mechanical models for representing the dynamic behavior of MR dampers. In some researches, MR damper was combined with base isolation system to enable the isolation system to operate more appropriately under strong or moderate vibrations [3-5]. Johnson et al. [6] used the MR damper to reduce the vibration of the cables induced with wind. Spencer et al. [2, 7-8] and Yang et al. [9-12] developed and introduced some models to represent the dynamic behavior of MR dampers and evaluate its performance. Other researches include developing one kind of MR dampers for base isolation system [13], modeling MR dampers with artificial neural networks [14], studying the fuzzy based model for these dampers [15] as well as evaluating the performance of MR dampers in seismic control of bridges [16] and structures [17].

Different algorithms have been proposed in literature to be used for semi-active control of structures which some of them have been applied in designing MR dampers [18-23]. The effectiveness of the clipped optimal control algorithm for designing MR dampers has been proved based on the results of numerical simulations and experimental researches [18].

In researches conducted on the MR damper system, mostly the performance of MR dampers in controlling the response of different kind of structures such as building structure and bridges has been studied using a semi-active control algorithm or in some studies new control algorithm has been suggested and its effectiveness has been evaluated. In addition, in some researches, different models have been suggested to represent the nonlinear dynamic behavior of MR dampers. In previous investigations, sufficient attention has not been paid

for optimal design of the MR damper including optimization of its parameters as well as semi-active control algorithm parameters while these parameters affect the performance of MR damper seriously. Therefore, it is need to determine a proper set of variables to achieve the best efficiency. Also in previous studies, the effect of designing criterion on MR damper performance has not been considered in detail while it could change the effectiveness of MR damper in reducing a specified response of structure. To overcome these shortcomings, in this research, it has been decided to study the optimal designing of MR dampers in detail while different kind of objective functions has been considered as design criteria. To this end, a method based on optimization problem has been proposed for designing MR dampers where the parameters of semi-active control algorithm and MR damper are considered as design variables while the minimization of structure response has been defined as objective function. To solve the nonlinear optimization problem, the genetic algorithms (GAs) has been used.

In the following section, the mechanical model of MR damper and structure-MR damper equation will be presented, next the optimal design procedure explanation will be followed by a numerical example.

2. MODIFIED BOUC-WEN MODEL

To study MR damper properties in applications, a model must be developed that could accurately represent the behavior of the damper. The Bouc-Wen mathematical model was first presented by Wen [24] in 1976 that is able to represent a variety of hysteric behaviors. In 1997, Spencer et al. [2] have developed this model and presented a new mechanical model for MR damper dynamic behavior in order to improve the behavior of force-velocity in Bouc-Wen model as shown in Figure 1.

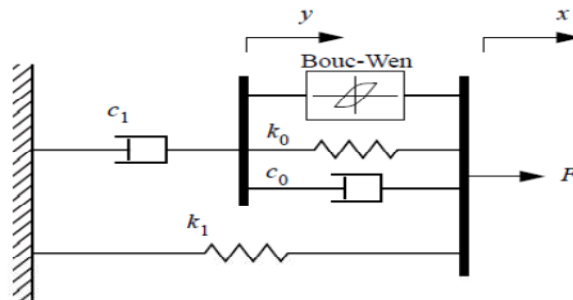

Figure 1. Simple mechanical model of the MR damper

In this model, the force generated by MR damper can be calculated using equation (1):

$$F = \alpha z + c_0(\dot{x} - \dot{y}) + k_0(x - y) + k_1(x - x_0) \quad (1)$$

Where the evolutionary variable (z) and the internal displacement of the damper (y) are obtained from the following equations:

$$\dot{z} = -\gamma|\dot{x} - \dot{y}|z|z|^{n-1} - \beta(\dot{x} - \dot{y})|z|^n + A(\dot{x} - \dot{y}) \quad (2)$$

$$\dot{y} = \frac{1}{c_0 + c_1} \{\alpha z + c_0 \dot{x} + k_0(x - y)\} \quad (3)$$

In these equations, k_1 is the stiffness added to the system by accumulator, c_0 and c_1 are the viscous damping at high and low velocities, respectively. k_0 is the stiffness at high velocities, x_0 is the initial displacement of the spring k_1 and x is the damper displacement.

The relationship between damper parameters and the applied voltage should be determined in order to determine a magnetic field dependent model. Since the yielding strength of MR fluid varies directly with the magnetic field intensity, parameter α in equations (1) and (3) is considered as a function of the applied voltage. Constant coefficients of viscous damping change linearly with the applied voltage, so the parameters c_0 and c_1 are defined as function of the input damper current. Dependence of the force generated by the MR damper on the input voltage is defined by the coefficients as follows:

$$\alpha = \alpha(u) = \alpha_a + \alpha_b u \quad (4)$$

$$c_0 = c_0(u) = c_{0a} + c_{0b} u \quad (5)$$

$$c_1 = c_1(u) = c_{1a} + c_{1b} u \quad (6)$$

Where u as a first order output filter can be calculated as follows:

$$\dot{u} = -\eta(u - V) \quad (7)$$

V is the input voltage to the damper. It should also be noted that the values of parameters c_{0a} , c_{0b} , c_{1a} , c_{1b} , α_a , α_b , x_0 , k_0 , k_1 , η , β , γ , n , A are all constant coefficients that are calculated by matching the behavior diagram of MR damper to the experimental results.

3. STRUCTURE-MR DAMPER MOTION EQUATION

Consider a multi-degree of freedom structure under one-dimensional ground acceleration. By assuming linear behavior for the structure, the vibration equation of the structure-MR damper system can be written as equation (8):

$$M_s \ddot{X} + K_s X + C_s \dot{X} = -M_s \Lambda \ddot{X}_g + \Gamma F \quad (8)$$

This equation is presented in the form of equations (9) and (10) in the state space where Z is the state vector of the structural system.

$$\dot{Z}(t) = AZ + BF + E\ddot{X}_g \quad (9)$$

$$Z = \begin{bmatrix} X & \dot{X} \end{bmatrix} \quad (10)$$

In the above equations, M_s , K_s and C_s are mass, stiffness and damping matrices of the main structure, respectively. X is the displacement vector of the structure floors relative to the ground, \ddot{X}_g , is ground acceleration, F is the control forces vector, Λ represents unit column matrix and the matrix Γ represents the position of MR dampers on the structure floors. Also, A , B and C are system matrices which can be obtained as follows:

$$A = \begin{bmatrix} O & I \\ -M_s^{-1}K_s & -M_s^{-1}C_s \end{bmatrix} \quad (11)$$

$$B = \begin{bmatrix} O \\ M_s^{-1}\Gamma \end{bmatrix} \quad (12)$$

$$E = - \begin{bmatrix} O \\ \Lambda \end{bmatrix} \quad (13)$$

4. SEMI-ACTIVE CONTROL ALGORITHM

The responses of structures equipped with MR damper are measured at each time step and used as feedback to determine the control force. Based on the results of previous theoretical and experimental researches it has been concluded that the clipped optimal control algorithm has been a proper semi-active control algorithm for designing MR dampers [18, 20, 25], hence in this paper, too, it has been decided to use this algorithm for designing optimal MR dampers.

In designing an optimal control system, it is required to reduce the structural responses with minimum energy or control force. To achieve this condition, in most strategies of active and semi-active algorithms a performance index is defined which includes a combination of structure responses and control forces. In this study, the Linear Quadratic Regulator (LQR) strategy has been used to design optimal controllers where the control force is determined through minimizing the standard second-order performance index according to equation (14):

$$J = \frac{1}{2} \int_{t_0}^{t_f} (CZ)'Q(CZ) + F_c'RF_c)dt \quad (14)$$

Where t_0 and t_f are initial and final time of applying the control force, F_c , respectively. Based on the decision that which structural response should be minimized, the matrix C is selected. Q and R are weighting matrices which indicate the relative importance of applying control force and controlling the response in minimization process.

It is noticeable that since the control force of MR damper depends on the displacements and velocities of the structure in position that the damper has been located, then it is not possible to generate the control force, F_i , directly by i th damper. Only the voltage v applied to the MR damper can be directly changed. The algorithm for selecting the voltage is

determined according to equation (15) and shown in Figure 2.

$$v_i = V_{\max} H((F_{ci} - F_i)F_i) \quad (15)$$

Where V_{\max} is maximum capacity of MR damper voltage and $H(\cdot)$ is the Heaviside-step function.

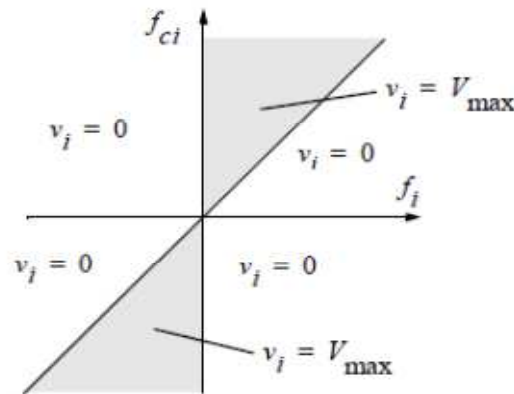

Figure 2. Graphical representation of the Clipped Optimal Control algorithm

5. GENETIC ALGORITHM

Optimization of a system means the minimization or maximization of a function that is an index of system performance. The idea of using genetic algorithm in engineering applications was presented for the first time by Holland [26]. In different fields of civil engineering, GA has been used for optimization such as designing optimal control systems to protect structures under earthquake excitation [27-28]. Genetic algorithm begins by creating random initial search points called initial population. By calculating the objective function for each individual, the fitness of each individual in the current population is evaluated. GA includes selection, crossover (recombination) and mutation operators [29].

In each generation, a set of individual is selected for mating based on their relative fitness. In this study, the stochastic universal sampling method [30] has been used to select individuals for mating based on their fitness values in the present population. In this method, the probability of selecting an individual is as follows:

$$P_{ind}(y_i) = \frac{F_{ind}(y_i)}{\sum_{i=1}^{N_{ind}} F_{ind}(y_i)} \quad i = 1, 2, \dots, N_{ind} \quad (16)$$

Where, $F_{ind}(y_i)$ is the fitness of y_i , $F_{ind}(y_i)$ is the probability of selecting y_i and N_{ind} is the number of individuals in each population. The selected individuals are then chosen randomly through crossover to produce newborns. The intermediate recombination method

[31] was used for recombination in which newborns are written based on linear combinations of parents chromosomes as follows:

$$G = P_1 + \alpha(P_2 - P_1) \quad (17)$$

Where G are the newborns chromosome genes, P_1 and P_2 are the corresponding genes of the parents chromosomes and α is a scale factor that is often selected randomly over [-0.25 1.25] to determine each gene of the newborns chromosome. To escape from local optimum point and to ensure searching all individuals, mutation operator in GA algorithm is used. If m_r is the percentage of mutated genes, N_{var} and N_{new} are the number of variables and newborns in each generation, respectively, the number of mutated genes is obtained as follows:

$$N_{mutated} = m_r \times N_{var} \times N_{new} \quad (18)$$

When the typical genetic algorithm is used for optimization of problems that have a large number of variables, the speed of convergence will be reduced; hence, to achieve the final answer many generations is required. It is recommended to divide the population of individuals into subpopulations that the new algorithm is called distributed genetic algorithm (DGA). In DGA small number of variables in each subpopulation causes to have better convergence speed than the traditional GA [32]. In DGA, Some individuals according to the migration rate value are selected from each subpopulation based on their fitness values and migrate to different subpopulations according to the migration interval value and migration strategy.

Based on the results of application of GA for optimization problems with continuous parameters, it has been suggested to use real-valued coding method to represent the variables [33] and in this research, too, the real-valued coding has been applied.

In this research, the elite strategy has been used which allows to go N_{elites} individuals of the current population to the next generation without any modification and the rest of the individuals of the current population are inserted by newborns. The individuals with higher fitness are selected as elites.

By selecting an insertion rate, η , N_{ins} number of newly produced chromosomes to be inserted are determined as:

$$N_{ins} = N_{new} \times \eta \quad (19)$$

Where η is selected within [0.8 0.9]. Also, the numbers of elite individuals are determined according to:

$$N_{elites} = N_{ind} - N_{ins} \quad (20)$$

6. OPTIMAL DESIGN OF MR DAMPER

The method proposed in this paper for optimal design of MR dampers is based on defining an optimization problem that includes different kind of objective function. In

addition, some constraints according to the limitations on MR damper capacity are considered in optimization problem. According to the equation (14), it is clear that the performance index, consequently the control force is determined as a function of the weighting matrices, therefore the method of selecting the parameters of the weighting matrices could affect the performance of MR damper. On the other hand, MR damper is designed to minimize a pre-specified response of the structure, hence based on the design criteria different combination of structural response such as maximum displacement, acceleration, internal forces could be included in the objective function. In this research minimization of the maximum displacement as safety criterion or minimization of the maximum acceleration as occupant's comfort ability criterion has been considered as objective function. By taking the parameters of the weighting matrices as design variables the optimization problem can be written as follows:

$$\text{Find: } Q_1, Q_2, Q_3, Q_4, \dots, Q_{i'} \quad (21)$$

$$\text{Minimize: } \begin{cases} X_{\max} = \max(|x_k(i)|, k=1, 2, \dots, k_{\max}) \\ \ddot{X}_{\max} = \max(|\ddot{x}_k(i)|, k=1, 2, \dots, k_{\max}) \end{cases} \text{ or} \quad (22)$$

$$Q_{\min} \leq Q_{i'} \leq Q_{\max} \quad (23)$$

$$R = \text{Constant} \quad (24)$$

Where, i' is the number of the variables, $Q_{i'}$ are the parameters of the weighting matrix, Q , k_{\max} is the maximum time step of the analysis, $x_k(i)$ and $\ddot{x}_k(i)$ are the relative displacement and acceleration of i th storey at k^{th} time step, respectively. Q_{\min} and Q_{\max} are the lower and the upper limits of the parameters which could be selected by designer.

7. NUMERICAL EXAMPLE

To explain the procedure of the proposed method for optimal design of MR dampers as well as to assess its effectiveness in improving the performance of MR damper a 10-storey shear frame has been considered with the following properties:

$$m_1 = m_2 = \dots = m_{10} = 360 \text{ ton} \quad (25)$$

$$k_1 = k_2 = \dots = k_{10} = 650 \text{ MN} / \text{m} \quad (26)$$

$$c_1 = c_2 = \dots = c_{10} = 6.2 \text{ MN.s} / \text{m} \quad (27)$$

Where m_i , k_i , and c_i are values of the mass, stiffness and structural damping of the i^{th} floor, respectively. The structure has been equipped with 10 MR dampers which one MR damper located on each floor as shown in Figure 3. In this study MR damper with the capacity of 1000 KN and the maximum voltage $V_{\max} = 10 \text{ Volts}$ has been used that its parameters have been reported in Table 1. The structure subjected to the N-S component of El-Centro (1940) earthquake record with $\text{PGA} = 0.34\text{g}$ as shown in Figure 4.

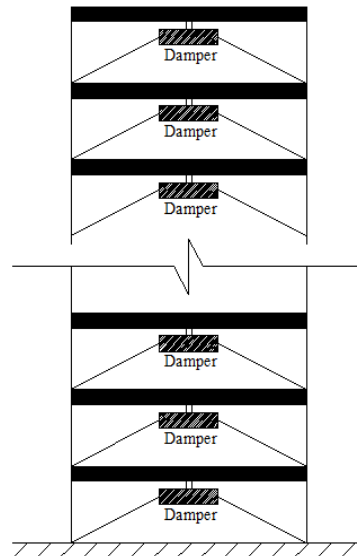

Figure 3. 10-storey shear frame equipped with 10 MR dampers

Table 1: Parameters of MR damper

Parameter	Value	Parameter	Value
α_a	46.2KN/m	k_0	0.002KN/m
α_b	41.2KN/m/V	k_1	0.0097KN/m
c_{0a}	110KN.s/m	x_0	0.18m
c_{0b}	114.3KN.s/m/V	γ	164m ⁻²
c_{1a}	8359.2KN.s/m	β	164m ⁻²
c_{1b}	4782.9KN.s/m/V	A	1107.2
η	100 s ⁻¹	n	2

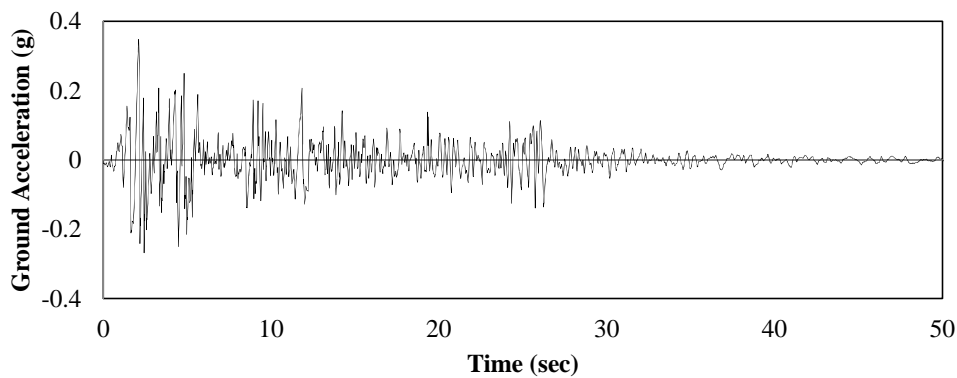

Figure 4. Ground acceleration of the 1940 El-Centro earthquake

In this study, the clipped optimal control algorithm with LQR controller has been used where the optimal control force will be determined according to the following equations:

$$F_c(t) = GZ(t) \quad (28)$$

$$G = -RB'P \quad (29)$$

Where G is the gain matrix and P is obtained from the solution of the Riccati equation given by:

$$Q + A'P + PA - PBR^{-1}B'P = 0 \quad (30)$$

7.1 DESIGNING OPTIMAL MR DAMPERS

For two different objective functions, two controllers have been designed which defined as:

Controller (1): for this controller the minimization of the maximum acceleration of the structure has been selected as objective function.

Controller (2): for this case, the minimization of the maximum displacement of the structure has been the main purpose.

Different arrangements could be selected for the weighting matrix, Q . In this paper to avoid from the complexity of the problem and to explain the procedure of the proposed method as well as to focus on the main objective of the paper, the weighting matrix, Q , has been defined as a diagonal matrix includes two variables Q_1 and Q_2 according to equation (31) and introduced by Arrangement (a).

Arrangement (a):

$$Q = \begin{bmatrix} Q_1[I]_{9 \times 9} & 0 \\ 0 & Q_2 \end{bmatrix} \quad (31)$$

In addition, Matrix R is considered as a diagonal matrix as follows:

$$R = R_1[I]_{10 \times 10} \quad (32)$$

The parameters of the DGA for solving the optimization problem have been selected as: Number of subpopulations, $N_{sub} = 2$, the number of individuals in each subpopulation, $N_{ind} = 25$, the number of elites, $N_{elites} = 5$, the rate of migration, $m_{rate} = 0.2$, the interval of migration, $m_{interval} = 20$ and mutation rate, $m_r = 0.04$.

For numerical dynamic analysis of structure-MR damper system and solving the optimization problem using DGA, programs have been developed using MATLAB software. To show the procedure of solving the optimization problem, for a sample, in Figure 5 for the case of Controller (1), the convergence of DGA for 3 runs has been reported where the maximum acceleration of the structure is defined as a function of the weighting matrix Q , by $F(Q)$. Also, in Figure 6 the values of objective function individuals in first and final generation for the optimal case has been shown. Based on the results it could be said that the method has a proper convergence speed so that the objective function value has decreased with increasing the number of generations or has been constant in some cases that

is due to elite strategy. Also all the runs had approximately the same final optimum answer.

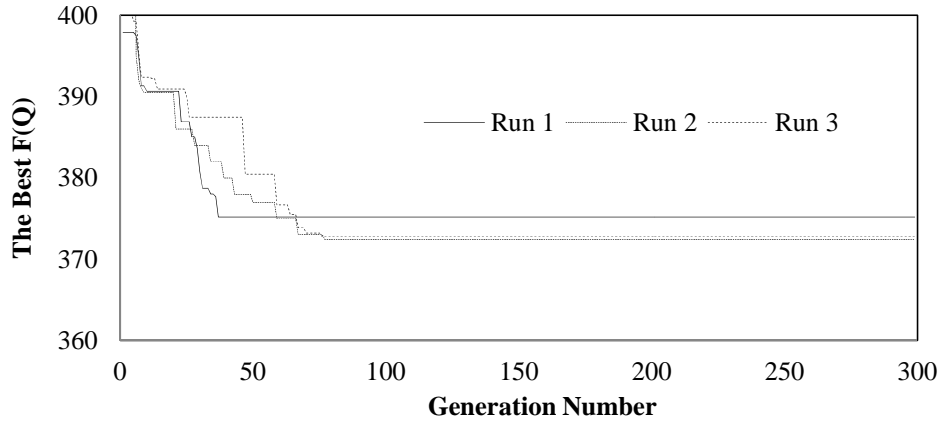

Figure 5. The best objective function for 3 runs during generations

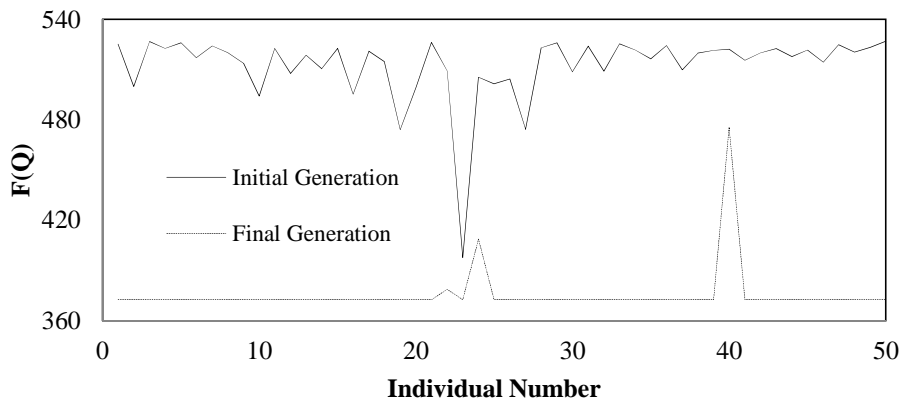

Figure 6. Objective function value at first and final generation

Following the same procedure, optimal MR dampers have been designed for both cases indicated by Controller (1) and (2). In Figures 7 and 8 the maximum acceleration and displacement of uncontrolled and controlled structures for all floors as well as in Table 2 the reduction in the maximum response of structure has been given for both cases of objective functions.

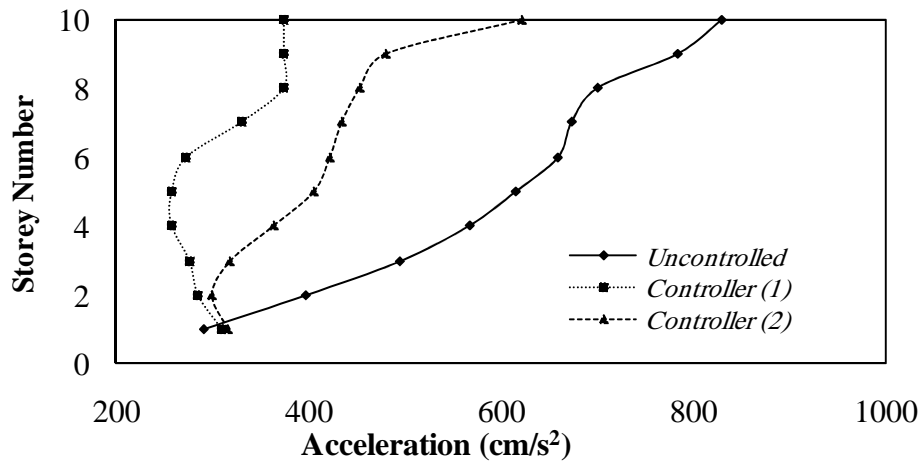

Figure 7. The maximum acceleration of the uncontrolled and controlled structures for two controllers

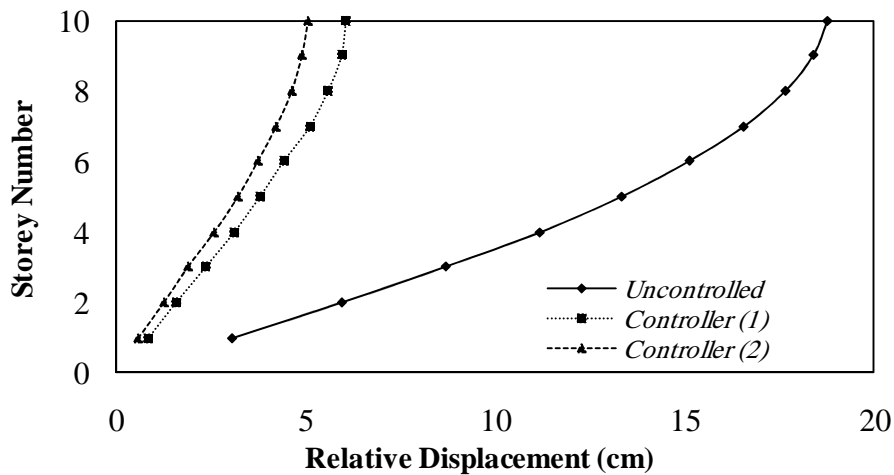

Figure 8. The maximum displacement of the uncontrolled and controlled structures for two controllers

Table 2: The Reduction in maximum response of structure for Arrangement (a)

Control Strategy	Responses	
	Displacement Reduction (%)	Acceleration Reduction (%)
Controller 1	68	55
Controller 2	73	25

By using the Controller (1) about 55% and 68% reduction has been achieved in maximum acceleration and displacement, respectively while for the Controller (2) the corresponding reductions has been about 25% and 73% for the maximum acceleration and displacement, respectively. It can be concluded that using MR damper has been more effective in reducing the maximum displacement of the structure rather than the maximum acceleration even for the Controller (1) which the maximum acceleration has been the main

objective. Also, if reducing the maximum acceleration is the main purpose of using MR damper, in the proposed method it is better to consider the minimization of the maximum acceleration as the objective function and the same idea could be used for other responses. This conclusion shows the capability of the proposed method in considering of reducing a desired response in design procedure. In addition, the importance of selecting a proper objective function in designing MR dampers could be concluded.

In Figures 9 and 10, the time history of the maximum acceleration and displacement of 10th floor for 20 seconds of vibration has been shown which shows the capability of optimal MR damper in reducing the response of the structure during vibration, effectively.

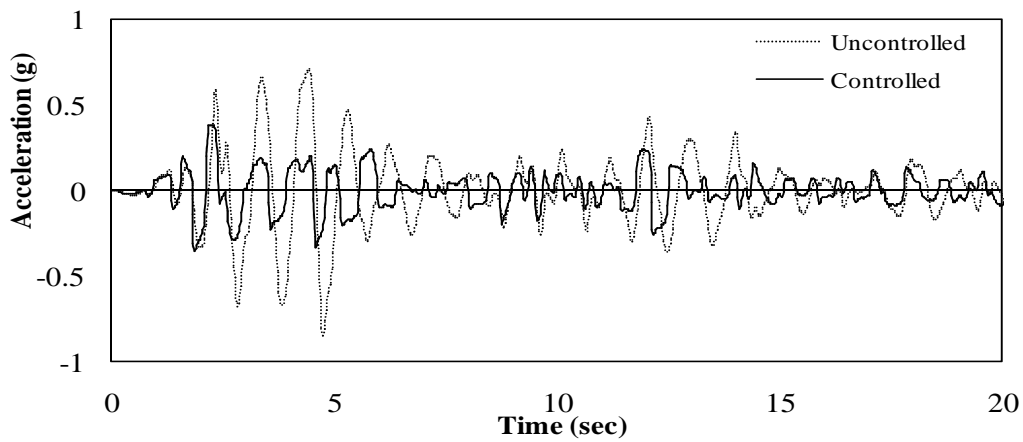

Figure 9. Time history of the 10th floor acceleration

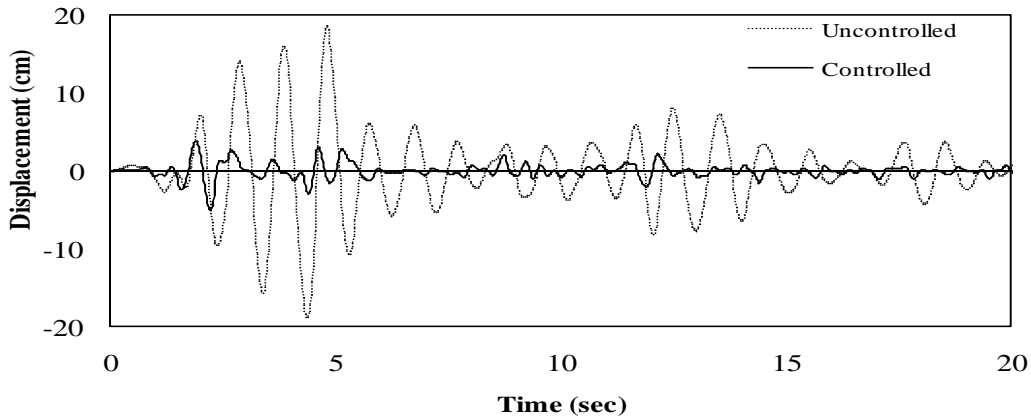

Figure 10. Time history of the 10th floor displacement

To show the efficiency of the proposed method in this research for determining the optimum values of the weighting matrices parameters, consequently in improving the performance of the MR damper, the same structure-MR dampers system subjected to the El-Centro excitation when the weighting matrices have been selected as $Q_1 = 0$ and $Q_2 = 1$ (Arrangement (b)), according to the suggestion by Dyke et al. [18]. In this arrangement, the weighting matrices parameters are fixed values without any optimization, also the matrix R

has been selected a fixed matrix. In Table 3 the reduction in the maximum acceleration and displacement of the structure for both Controllers (1) and (2) has been reported. When using the Controller (1) about 23% and 33% reduction in the maximum acceleration and displacement has been achieved while for the Controller (2), the corresponding reductions has been about 38% and 51% for the maximum acceleration and displacement, respectively. Comparing the results obtained for Arrangements (a) and (b) (Tables (1) and (2)) shows that using the optimization procedure for optimal design of MR dampers has been more effective and this method could be suggested as an effective and simple procedure for designing optimal MR dampers in practical application.

Table 3: The Reduction in the maximum response of structure for Arrangement (b)

Control Strategy	Responses	
	Displacement Reduction (%)	Acceleration Reduction (%)
Controller 1	33	23
Controller 2	51	38

To compare the advantage of using the optimization based method in taking more benefits of the MR capacity, for both cases of Arrangements (a) and (b) the maximum control force of MR dampers in each storey has been reported in Figures 11 and 12. Results show that in both controllers (1) and (2), for the case of using optimal MR damper, the maximum control force has been about 812 kN and 908 kN while the corresponding value for the Arrangements (b) has been 278 kN and 445 kN, respectively. Hence, it could be concluded that using the proposed method for designing MR damper has caused to utilize up to 90% of MR damper potential capacity (1000 kN) and consequently to achieve significant reduction in structure response.

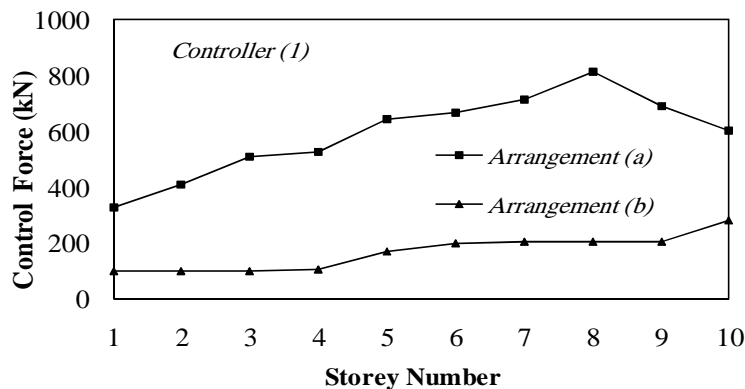

Figure 11. The maximum control force for when using Controller (1)

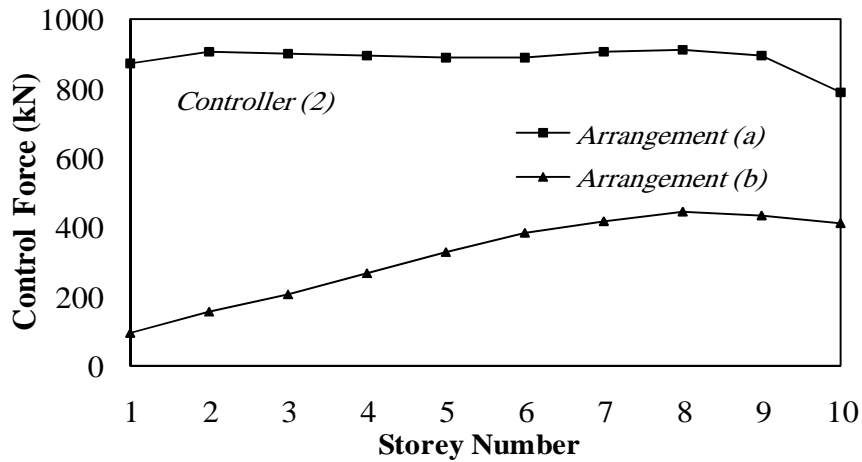

Figure 12. The maximum control force when using Controller (2)

7.2 ASSESSMENT OF THE DESIGN EARTHQUAKE EFFECT

In this section it is desired to evaluate the performance of the optimal MR damper designed using the El-Centro earthquake as input, in reducing the seismic response of the structure under other excitations which are different from design record regarding peak ground acceleration (PGA) and frequency content. To this end, the structure-MR dampers designed using the Arrangement (a) and Controllers (1) and (2) subjected to real earthquakes including the Northridge(1994, PGA=0.84g), Hachinohe (1968, PGA=0.23g) and Kobe (1995, PGA=0.83g) records and a White noise excitation with PGA=0.4g as shown in Figure 13.

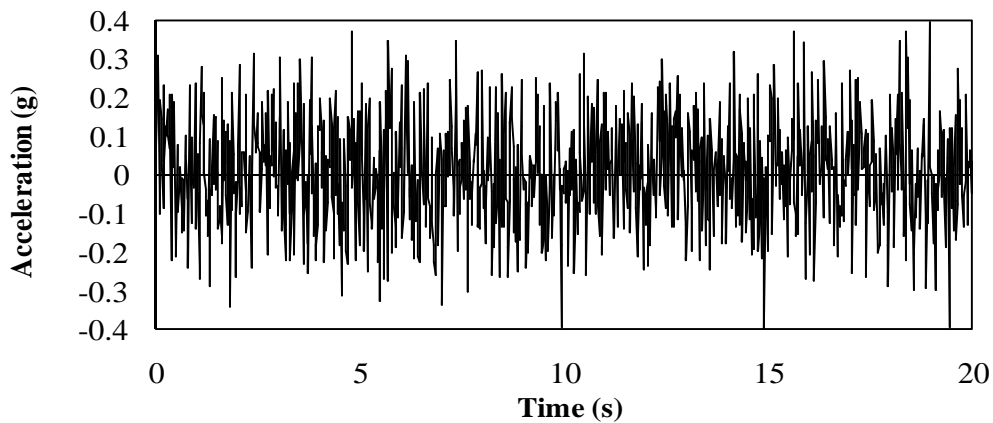

Figure 13. Ground acceleration of the White noise excitation

Figures 14 and 15 shows the reduction in the maximum acceleration and displacement of the structure under different base excitations for Controllers (1) and (2).

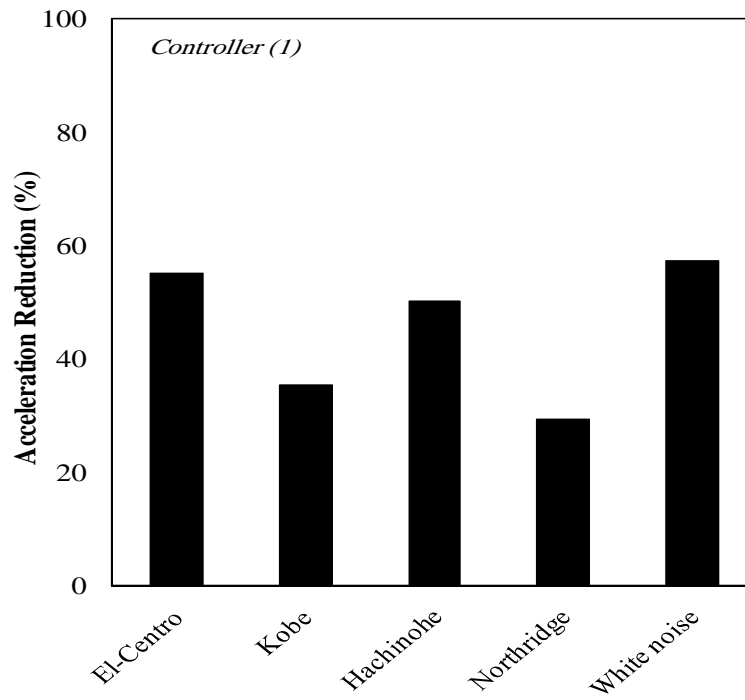

Figure 14. Reduction in the maximum acceleration of the structure under different base excitations for Controller (1)

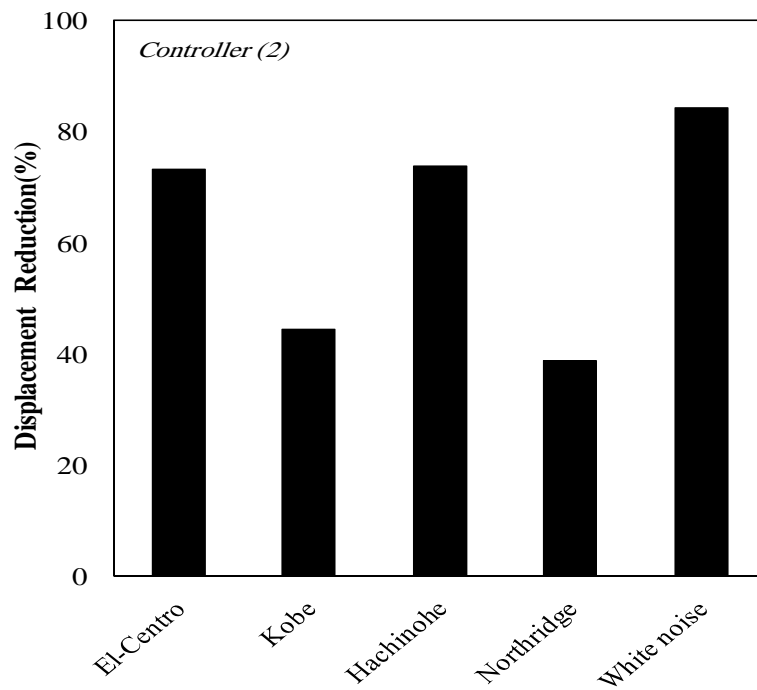

Figure 15. Reduction in the maximum displacement of the structure under different base excitations for Controller (2)

As can be seen from Figures 14 and 15, for both Controllers (1) and (2), the optimal controller, designed using the El-Centro record, has been able to provide a favorable decrease in the maximum acceleration and displacement under other excitations though the efficiency depends on the characteristics of the excitation. In this case study, for Controller (1), reduction in the maximum acceleration has been about 57% and 50% under the White noise and the Hachinohe excitations while the reduction has been about 35% and 29% under the Kobe and the Northridge records which are stronger and near-field excitations. Also, for the controller (2), the maximum reduction in the maximum displacement has been about 84% and 74% under the White noise and the Hachinohe excitation while the corresponding values under the Kobe and the Northridge have been about 44% and 39%. In addition, similar to the results obtained for the El-Centro excitation (design record), under testing records, too, MR damper has been more effective in decreasing the maximum displacement rather than the maximum acceleration. According to the results, as design guideline it is suggested that in designing MR dampers in a specific area, it is better to use the design record of that area as input excitation based on seismic design codes regulations.

8. CONCLUSIONS

In this study, an effective method based on using the genetic algorithm (GA) for optimal design of MR dampers has been proposed. To this end, an optimization problem has been defined where the weighting matrices of clipped optimal control algorithm with LQR control strategy have been considered as the variables and the minimization of the maximum response of the structure as objective function. To assess the effect of the objective function on MR damper performance, two different kinds of objective functions including the minimization of the maximum acceleration and the minimization of the maximum displacement of the structure have been considered. A 10-storey shear building frame equipped with 10 MR dampers, distributed uniformly over the floors, subjected to the El-Centro excitation and optimal MR dampers have been designed for both kinds of objective functions and two different arrangements of the weighting matrices. Results of the numerical simulation have shown the effectiveness of the proposed method in designing optimal MR damper that could reduce the response of the structure, effectively and make it possible to utilize a significant portion of MR dampers potential capacity. In the case study of this research, the reduction about 55% and 73% in the maximum acceleration and displacement of the structure has been achieved while the corresponding values have been about 23% and 51% for non-optimal case. In addition, in this research the importance of selecting a proper objective function to improve the performance of MR damper in reducing a specific response of the structure has been shown. For example, the reduction in the maximum acceleration has been 55% when the minimization of the maximum acceleration has been selected as objective function while the corresponding value has been 25% when using the minimization of the maximum displacement as objective function. In addition, testing optimal MR dampers under different excitations that are different from the design record regarding the peak ground acceleration and the frequency content shows that though in most cases MR damper could reduce the response of the structure under different excitations but the performance of MR damper depends on the earthquake characteristics. In this research,

the reduction in the maximum acceleration and displacement of the structure under design record has been about 55% and 73% while the corresponding values has been about 29% and 39% when the structure subjected to the Northridge excitation. To improve the performance of MR damper in a specific area, it is better to use the design record of that area as input excitation.

REFERENCES

1. Soong TT, Spencer Jr. BF. Supplemental energy dissipation: state-of-the-art and state-of-the-practice, *Eng Struct* 2002; **24**(3): 243-59.
2. Spencer Jr. BF, Dyke SJ, Sain MK, Carlson J.D. Phenomenological model of a magnetorheological damper, *J Eng Mech* 1997; **123**(3): 230-38.
3. Spencer Jr. BF, Johnson EA, Ramallo JC. 'Smart' isolation for seismic control, *JSME Int J: Special Issue on Frontiers of Motion and Vibration Control*, Series C 2000; **43**(3): 704-11.
4. Ramallo JC, Johnson EA, Spencer Jr. BF. Smart base isolation systems, *J Eng Mech* 2002; **128**(10): 1088-99.
5. Yoshioka H, Ramallo JC, Spencer Jr. BF. 'Smart' base isolation strategies employing magnetorheological dampers, *J Eng Mech* 2002; **128**(5): 540-51.
6. Johnson EA, Baker GA, Spencer Jr. BF, Fujino Y. Semiactive damping of stay cables, *J Eng Mech* 2001; **133**(1): 1-11.
7. Spencer Jr. BF, Carlson JD, Sain MK, Yang G. On the current status of magnetorheological dampers: seismic protection of full-scale structures, *Proc Am Contr Conf*, Albuquerque, NM, USA, 1997, pp. 458-62.
8. Spencer Jr. BF, Yang G, Carlson JD, Sain MK. 'Smart' dampers for seismic protection of structures: a full-scale study, *Proceedings of the 2nd World Conference on Structural Control*, Kyoto, Japan, 1998, pp. 417-26.
9. Yang G, Ramallo JC, Spencer Jr. BF, Carlson JD, Sain MK. Dynamic Performance of large-scale MR fluid dampers, *CD-ROM Proceedings 14th ASCE Engineering Mechanics Division Conference*, Austin, Texas, J.L. Tassoulas, Editor, 2000, pp. 21-4.
10. Yang G, Spencer Jr. BF, Carlson JD, Sain MK. Large-scale MR fluid dampers: Modeling and dynamic performance consideration, *Eng Struct* 2002; **24**(3): 309-23.
11. Yang G, Spencer Jr. BF, Carlson JD, Sain MK. Dynamic modeling and performance considerations on full-scale MR fluid dampers, *Proceedings of the 8th International Conference on Structural Safety and Reliability*, Newport Beach, California, 2001.
12. Yang G, Jung HJ, Spencer Jr. BF. Dynamic model of full-scale MR dampers for civil engineering applications, *Proceedings US-Japan Workshop on Smart Structures for Improved Seismic Performance in Urban Region*, Seattle, Washington, 2001.
13. Fujitani H, Sodeyama H, Tomura T, Hiwatashi T, Shiozaka Y, Hata K, Sunakoda K, Morishita S, Soda S. Development of 400KN magnetorheological damper for a real base-isolated building, *Proceedings of SPIE Smart Structures and Materials: Damping and Isolation*, San Diego, California, 2003, pp. 265-76.

14. Wang D, Liao W. Neural network modeling and controllers for magnetorheological fluid dampers, *IEEE International Fuzzy Systems Conference*, Melbourne, Australia, 2001, pp. 1323-26.
15. Oh J, Roschke P, Lin P, Carlson J, Sunakoda K. Experimental behavior and neuro-fuzzy modeling of 30-ton magnetorheological damper, *KSCE J Civil Eng* 2004; **8**(2): 213-19.
16. Jane HJ, Spencer Jr. BF, Lee IW. Control of seismically excited cable-stayed bridge employing magnetorheological fluid dampers, *J Struct Eng* 2003; **129**(7): 873-83.
17. Zapateiro M, Karimi HR, Luo N, Phillips BM, Spencer BF. Jr. Semiactive backstepping control for vibration reduction in a structure with magnetorheological damper subject to seismic motions, *J Intell Mater Syst Struct* 2009; **20**(17): 2037-53.
18. Dyke SJ, Spencer Jr. BF, Sain MK, Carlson JD. Modeling and control of magnetorheological dampers for seismic response reduction, *Smart Mater Struct* 1996; **5**(5): 565-75.
19. Dyke SJ, Spencer Jr. BF, Sain MK, Carlson JD. A new semi active control device for seismic response reduction, *Proceedings of the 11th ASCE Engineering Mechanics Specialty Conference*, Fort Lauderdale, Florida, 1996, pp. 886-89.
20. Dyke SJ, Spencer Jr. BF, Sain MK, Carlson JD. Seismic response reduction using magnetorheological dampers, *Proceedings 13th Triennial World Congress, International Federation of Automatic Control*, San Francisco, California, 1996, pp. 145-50.
21. Dyke SJ, Spencer Jr. BF. A comparison of semi-active control strategies for the MR damper, *Proceedings of the IASTED International Conference on Intelligent Information Systems*, Bahamas, 1997, pp. 580-84.
22. Yi F, Dyke SJ. Structural control systems: performance assessment, *Proc Am Contr Conf* 2000, Chicago, IL, pp. 14-8.
23. Jansen LM, Dyke SJ. Semiactive control strategies for MR dampers: comparative study, *J Eng Mech* 2000; **126**(8): 795-803.
24. Wen YK. Method of random vibration of hysteretic systems, *J Eng Mech Div* 1976; **102**(2): 249-63.
25. Dyke SJ, Spencer Jr. BF, Sain MK, Carlson JD. Experimental verification of semi-active structural control strategies using acceleration feedback, *Proceedings of the 3rd International Conference on Motion and Vibration Control*, Chiba, Japan, 1996, pp. 291-96.
26. Holland JH. *Adaptation in natural and artificial systems*, Ann Arbor: The University of Michigan Press, 1975.
27. Mohebbi M. Minimizing Hankel's Norm as design criterion of multiple tuned mass dampers, *Iranian J Optim Civil Eng* 2013; **3**(2): 271-88.
28. Mohebbi M, Moradpour S, Ghanbarpour Y. Improving the seismic response of nonlinear steel structures using optimal MTMDs, *Iranian J Optim Civil Eng* 2014; **4**(1):137-50.
29. Goldberg DE. *Genetic algorithms in search, optimization and machine Learning*, Addison-Wesley Longman Publishing Co, Inc. Boston, MA, USA, 1989.
30. Baker JE. Reducing bias and inefficiency in the selection algorithm, *Proceedings of the International Conference on Genetic Algorithms*, Hillsdale, New Jersey, USA, Lawrence Erlbaum Associates, 1987, pp. 14-21.
31. Mühlenbein H, Schlierkamp-Voosen D. Predictive models for the breeder genetic algorithm: I. Continuous parameter optimization, *Evol Comput*, 1993; **1**(1): 25-49.

32. Starkweather T, Whitley D, Mathias K. Optimization using distributed genetic algorithms, New York, *Springer-Verlag Lecture Notes in Computer Science* 1990; **496**: 176-85.
33. Jenkins WM. A decimal-coded evolutionary algorithm for constrained optimization, *Comput Struct* 2002; **80**(5): 471-80.