



FEASIBILITY OF PSO-ANFIS-PSO AND GA-ANFIS-GA MODELS IN PREDICTION OF PEAK GROUND ACCELERATION

A. Kaveh^{*,†,1}, S. M. Hamze-Ziabari¹ and T. Bakhshpoori²

¹*Centre of Excellence for Fundamental Studies in Structural Engineering, Iran University of Science and Technology, Tehran-16, Iran*

²*Faculty of Technology and Engineering, Department of Civil Engineering, East of Guilan, University of Guilan, Rudsar-Vajargah, Iran*

ABSTRACT

In the present study, two new hybrid approaches are proposed for predicting peak ground acceleration (PGA) parameter. The proposed approaches are based on the combinations of Adaptive Neuro-Fuzzy System (ANFIS) with Genetic Algorithm (GA), and with Particle Swarm Optimization (PSO). In these approaches, the PSO and GA algorithms are employed to enhance the accuracy of ANFIS model. To develop hybrid models, a comprehensive database from Pacific Earthquake Engineering Research Center (PEER) are used to train and test the proposed models. Earthquake magnitude, earthquake source to site distance, average shear-wave velocity, and faulting mechanisms are used as predictive parameters. The performances of developed hybrid models (PSO-ANFIS-PSO and GA-ANFIS-GA) are compared with the ANFIS model and also the most common soft computing approaches available in the literature. According to the obtained results, three developed models can be effectively used to predict the PGA parameter, but the comparison of models shows that the PSO-ANFIS-PSO model provides better results.

Keywords: ANFIS; metaheuristics; PSO; GA; peak ground acceleration.

Received: 20 February 2017; Accepted: 18 June 2017

1. INTRODUCTION

Ground motion prediction equations (GMPEs) are used for the estimation of the ground motion parameters. Ground motion parameters are needed for the design and evaluation of important structures. The commonly used ground motion parameters in time domain are peak ground acceleration (PGA), peak ground velocity (PGV) and peak ground

*Corresponding author: Centre of Excellence for Fundamental Studies in Structural Engineering, Iran University of Science and Technology, Narmak, Tehran, P.O. Box 16846-13114, Iran

†E-mail address: alikaveh@iust.ac.ir (A. Kaveh)

displacement (PGD). In addition to the physical modeling and on-site investigation methods which are extensive, cumbersome and costly, GMPEs can be developed based on other two approaches: traditional regression analysis method and soft computing (SC) based methods. Both methods relate the ground motion parameters to some independent variables such as earthquake magnitude, source to site distance, site conditions, seismic wave propagation and earthquake source characteristics [1]. The first method represents a significant advancement in the state-of-the-art in empirical ground-motion modeling. And also in recent years the available ground motion databases have been greatly expanded. Attenuation relations developed in the Pacific Earthquake Engineering Research Center (PEER) in two phases, NGA-West1 [2, 3] and NGA-West2 [4], which are known as CB08 and CB14, respectively, are the most common predictive models among many others [5, 6]. The latter one have many advantages such as the ability in learning and generalizing interactions among many variables, and no need to assume an equation form. With the recent advances in the field of artificial intelligence and soft computing techniques, these methods have been considered for a suitable alternative in earthquake engineering prediction problems and also in peak time domain strong ground motion estimation problem. From the SC based prediction models one can refer to back propagation neural networks [7], artificial neural networks [8], hybrid model of genetic programming [9], hybrid model coupling of artificial neural network with simulated annealing [10], multi expression programming [11], a hybrid model of GP and SA [12], M5' [13], support vector machine algorithms [14], and randomized ANFIS [1].

Peak time-domain strong ground motion parameters estimation problem is vital in earthquake engineering and risk assessment. Owing to the complex nature of the problem, accurate SC-based prediction models development is indispensable. The main objective of this paper is to predict the peak ground acceleration (PGA) parameter using two novel hybrid approaches. The proposed approaches are based on the combinations of Adaptive Neuro-Fuzzy System (ANFIS) with Genetic Algorithm (GA), and with Particle Swarm Optimization (PSO). Adaptive Neuro-Fuzzy Inference System (ANFIS) is one of the widely-used data mining methods that integrates both neural networks and fuzzy logic principles [15]. In these approaches, the PSO and GA algorithms are employed to enhance the accuracy of ANFIS model. In the hybrid approach, GA [16] and PSO [17] are used to optimize and tune the values of antecedent and consequent parameters of the ANFIS model. GA and PSO are the first developed evolutionary based and swarm based metaheuristics, respectively [18]. To develop hybrid models, a comprehensive database from Pacific Earthquake Engineering Research Center (PEER) are used to train and test the proposed models. Earthquake magnitude, earthquake source to site distance, average shear-wave velocity, and faulting mechanisms are used as predictive parameters. The performances of the developed hybrid models (PSO-ANFIS-PSO and GA-ANFIS-GA) are compared with the ANFIS model and also the most common soft computing approaches available in the literature. According to the obtained results, three developed models can be effectively used to predict the PGA parameter, but the comparison of models shows that the PSO-ANFIS-PSO model provides better results.

The remaining section of the paper are organized as follows. Section 2 presents the methodology of hybridizing ANFIS with GA and PSO after outlining ANFIS, PSO and GA. Section 3 develops three predictive models based on ANFIS, PSO-ANFIS-PSO and GA-

ANFIS-GA. Results and discussions are made in Section 4. Concluding remarks are made in the last section.

2. METHODOLOGY

2.1 ANFIS

Adaptive Neuro-Fuzzy Inference System (ANFIS) is one of the widely-used data mining methods that integrates both neural networks and fuzzy logic principles. The ANFIS method was introduced by Jang in 1993 [15]. The ANFIS architecture consists of five layers as shown in Fig. 1. The nodes of layers are divided into fixed and adaptable types. The nodes of layers 1 and 4 are adaptable while the nodes of layers 2, 3, and 5 are fixed.

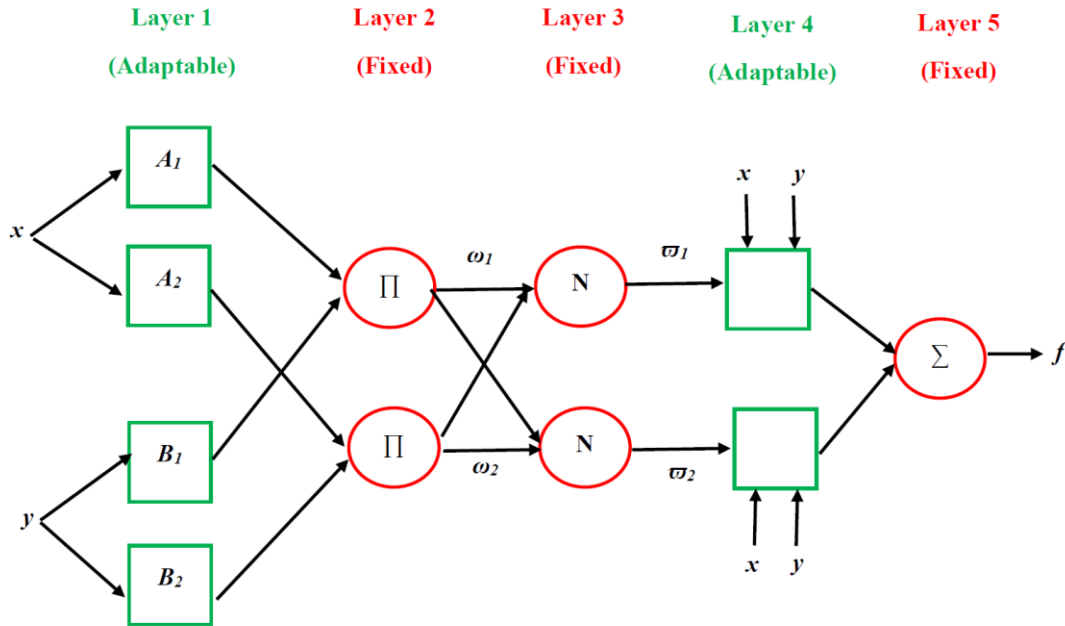

Figure 1. ANFIS architecture

To explain the role of each layer, let consider the two fuzzy if-then rules as follows:

$$\begin{aligned} \text{Rule1: if } x \text{ is } A_1 \text{ and } y \text{ is } B_1 \text{ then } f &= p_1x + q_1y + r_1 \\ \text{Rule2: if } x \text{ is } A_2 \text{ and } y \text{ is } B_2 \text{ then } f &= p_2x + q_2y + r_2 \end{aligned} \quad (1)$$

where x and y are input variables, A_i and B_i are the fuzzy sets, f is the output, p , q , and r are the design parameters that should be determined during the training process of ANFIS algorithm. The function of each layer can be stated as follows:

Layer 1: in this layer, each node i is represented by a membership function (i.e. Triangle, Trapezoidal, Gaussian, or generalized Bell function) as follows:

$$O_{1,i} = \sigma_{A_i(x)} \quad (2)$$

$$O_{1,i} = \sigma_{B_i(x)} \quad (3)$$

where A_i is the linguistic variable, x is the input to node i and $O_{1,i}$ is the membership function of A_i , which is usually defined by a Gaussian function as follows:

$$\sigma_{A_i(x)} = \exp\left(\frac{-(x-c)^2}{\sigma^2}\right) \quad (4)$$

where σ is the standard deviation and c is the center of the above Gaussian membership function.

Layer 2: the firing strength of a rule is determined by the following product as:

$$\omega_i = \sigma_{A_i(x)} \times \sigma_{B_i(x)}, \quad i=1,2 \quad (5)$$

Layer 3: the firing strength of each rule is normalized by calculating the ratio of the i th rule's firing strength to the sum of all rules' firing strength.

$$\bar{\omega} = \frac{\omega_i}{\omega_1 + \omega_2} \quad (6)$$

Layer 4: the conclusion part of fuzzy rules are calculated as follows:

$$\bar{\omega} = \frac{\omega_i}{\omega_1 + \omega_2} \quad (7)$$

Layer 5: summing up all the outputs coming from Layer 4.

2.2 GA

Genetic algorithm is one of the firstly developed metaheuristic algorithms firstly presented by Holland in 1975 and is based on the genetic process of biological organisms [16]. Although idea of mimicking the evolution in programming had been used by others (e.g. Evolutionary Strategies (ESs) and Genetic Programming (GP)), but recombination in addition to mutation and selection was firstly used in the GAs which is the key feature of them [19].

Genetic algorithms have three characteristic operators, namely selection, crossover and mutation. A potential solution to a problem may be represented as a set of parameters. These parameters (known as genes) are joined together to form a string of values (chromosome). In genetic terminology, the set of parameters represented by a particular chromosome is referred to as an individual. The fitness of an individual depends on its chromosome and is evaluated by the fitness function. During the reproductive phase, the individuals are selected

from the population and recombined, producing offspring, which comprise the next generation. Parents are randomly selected from the population using a scheme, which favors fitter individuals. Having selected two parents, their chromosomes are recombined, typically using mechanisms of crossover and mutation. Mutation is usually applied to some individuals, to guarantee population diversity [20].

2.3 PSO

PSO is a population based metaheuristic algorithm developed by Kennedy and Eberhart [17] that simulates social behaviors of animals. Similar to other metaheuristic methods, PSO is initialized with a population of random designs, named particles, that are updated in each generation to search the optimum. Each particle is associated with a velocity vector adaptively changed in the optimization process. Particles move through the search space from their current positions with velocity vectors that are dynamically adjusted according to their current velocity, best self-experienced position and the best global-experienced position. PSO algorithm constitutes the simple conduct rules for search ability of each particle as follows:

$$\begin{aligned} X_i^{k+1} &= X_i^k + V_i^{k+1} \\ V_i^{k+1} &= \omega V_i^k + c_1 r_1 (P_i^k - X_i^k) + c_2 r_2 (P_g^k - X_i^k) \end{aligned} \quad (8)$$

The new position of particles X_i^{k+1} is obtained by adding the new velocity V_i^{k+1} to the current position X_i^k . V_i^k , P_i^k and P_g^k are previous velocity, the best position visited by each particle itself and the best solution the swarm has found so far, respectively. ω is an inertia weight to control the influence of the previous velocity, r_1 and r_2 are two random numbers uniformly distributed in the range of (0, 1), and c_1 and c_2 are two learning factors which control the influence of the cognitive and social components [21].

2.4 ANFIS trained by PSO and GA

In the ANFIS model, two types of parameters (i.e. antecedent and consequent parameters) are tuned by gradient-based methods such as Least Square Error (LSE) and Steep Descend Error (SDE). The answers of mentioned gradient-based method may stuck in the local optimum. Therefore, applying metaheuristic algorithms such as PSO or GA algorithms with random search nature can be considered as alternative and useful approaches. The antecedent parameters related to the membership functions, which can be optimized by the evolutionary algorithms, are $\{\sigma_i, c_i\}$ or ω_i in Eq. (4). Each of these parameters contains N genes, where N is the number of membership functions. The consequent parameters $\{p_i, q_i, r_i\}$ in Eq. (7) can be also trained during the optimization algorithm. In the conclusion part, $(I+1) \times R$ genes generate each chromosome. The objective function of the used evolutionary algorithms is the root mean squared error (RMSE).

To solve the mentioned optimization problem using PSO-ANFIS-PSO and GA-ANFIS-GA, the weight ω_i resulting from the fuzzy antecedent parameters as well as the linear parameters such as p , q , and r are tuned through PSO and GA algorithms. Fig. 2 illustrates the flow diagram of the proposed PSO-ANFIS-PSO and GA-ANFIS-GA models in which

the methodology of employing both embedded PSO and GA algorithms is described.

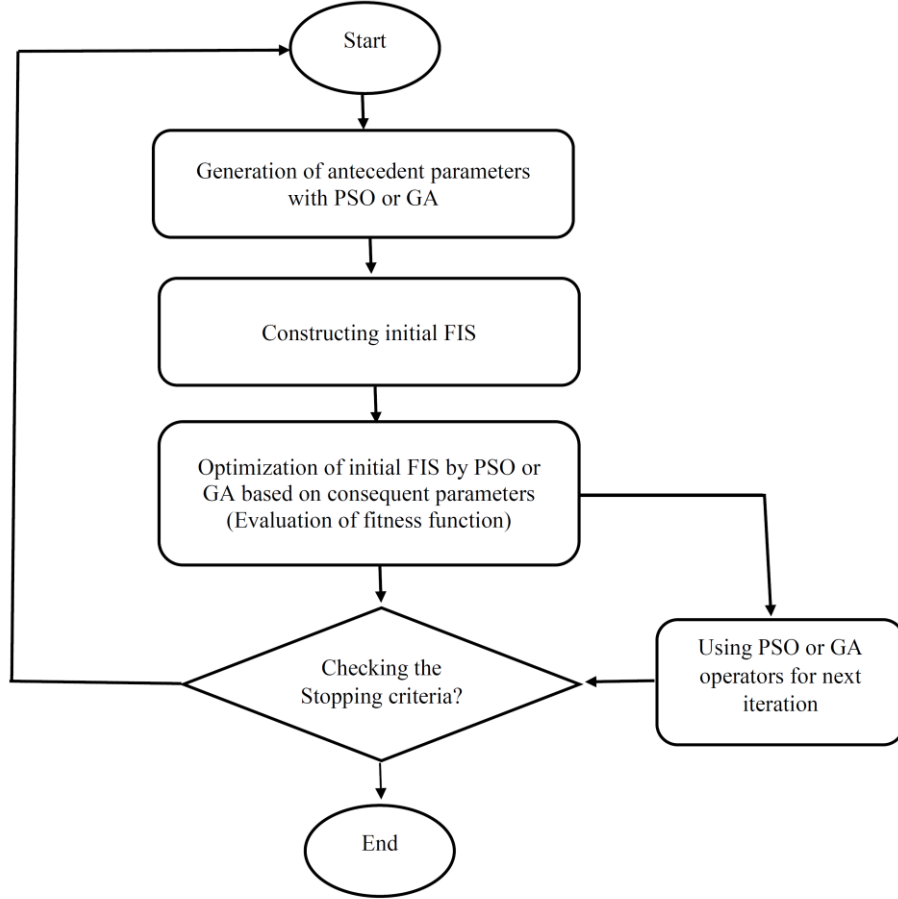

Figure 2. ANFIS architecture

3. MODEL DEVELOPMENT

To develop new predictive model, a comprehensive database reported in Pacific Earthquake Engineering Research Center (PEER) is used. The PGA parameter is modelled in terms of four independent parameters including moment magnitude (M_w), closest distance to rupture (R_{ClstD}), style of faulting, and average shear-wave velocity over top 30 m of site (V_{s30}). According to Douglas [5], the following formulation is used to develop new model for PGA parameter as:

$$\ln(PGA) = f(M, \ln(R), V_{s,30}, F) \quad (9)$$

where F stands for the style of faulting. Three different styles of faulting based on this parameter are determined by Campbell and Bozorgnia [3]. The values of this parameter for each type of faulting are as follows: reverse (dip slip with hanging-wall side up, $F=1$),

normal (dip slip with hanging-wall side down, $F=2$); and (3) strike-slip (horizontal slip, $F=3$). The schematic definition of each faulting type is shown in Fig. 3 (a). The percentage of each type of faulting is also shown in Fig. 3 (b). As shown, the reverse faulting is the main style of faulting in the database used. Furthermore, the boxplot of different predictive and output parameters is depicted in Fig. 4. This plot presents all possible scatter plots between input and output parameters one by one. The plots placed in the diagonal of this matrix are the histograms of input and output parameters for the whole database. As shown, the predictive variables covers a wide range of magnitudes and distances.

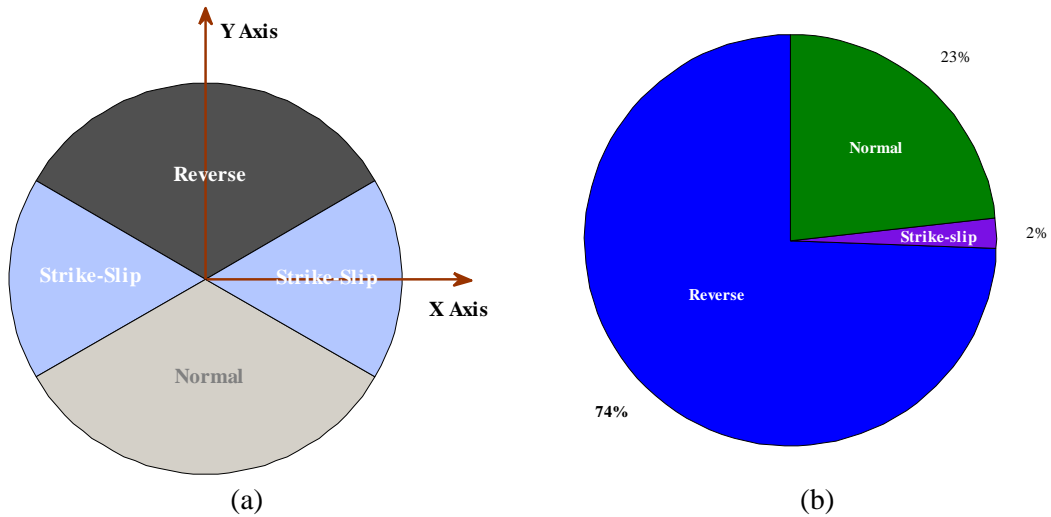

Figure 3. Three different styles of faulting: (a) schematic definition, (b) percentage of each type

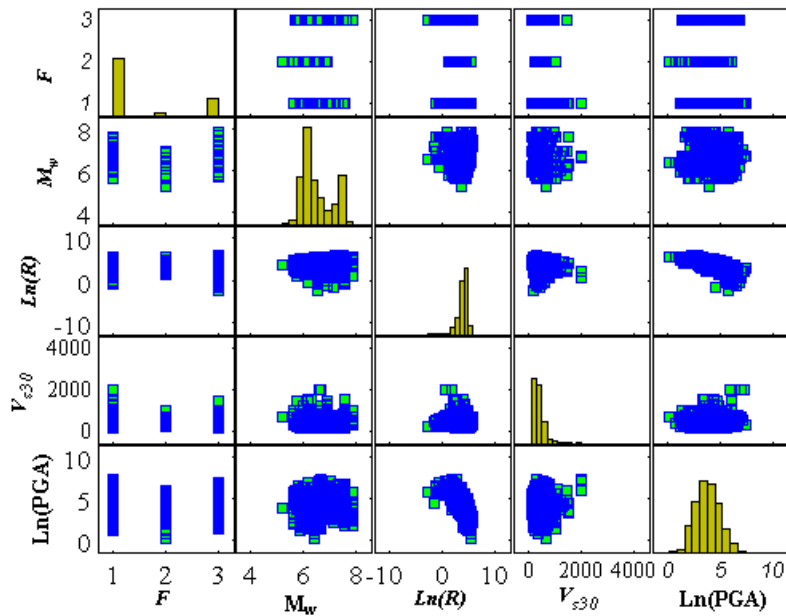

Figure 4. Boxplot of different predictive and output parameters

A filtered database contains 2815 records is employed to develop evolutionary algorithms based on ANFIS, PSO, and GA methods. From the 2815 selected data points, 2252 (80%) data points were chosen as the training data, and the remaining 563 data points were used as the testing data to evaluate the model's performance. After arrangement of datasets, the PSO-ANFIS-PSO and GA-ANFIS-GA are applied to estimate the PGA parameter. Table 1 presents both employed PSO and GA algorithm parameters in which stopping criteria only meet the number of iterations. The PSO and GA parameters reported in the table are chosen based on the authors' experiences within a trial-and-error process. Furthermore, Fig. 5 shows the evolution of RMSE values for both hybrid models versus number of iterations in the estimation of PGA for the testing datasets.

Table 1: PSO and GA algorithm parameters.

Model		Model	
PSO parameters		GA parameters	
Population Size	25	Population Size	25
Maximum Number of Iterations	2000	Maximum Number of Iterations	2000
Inertia Weight	1	Crossover Percentage	0.4
Inertia Weight Damping Ratio	0.99	Mutation Percentage	0.7
Personal Learning Coefficient	1	Mutation Rate	0.15
Global Learning Coefficient	2	Selection Pressure	8
-	-	Gamma	0.7

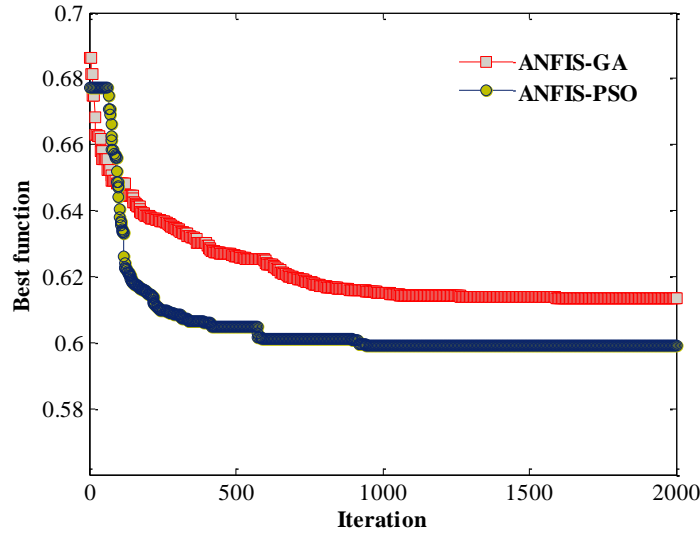

Figure 5. Evolution of RMSE in both PSO-ANFIS-PSO and GA-ANFIS-GA models for testing dataset versus number of iterations in the estimation of PGA

5. RESULTS AND DISCUSSIONS

The results of ANFIS, GA-ANFIS-GA, and PSO-ANFIS-PSO are presented in this section. In this way, mean absolute error (MAE), root mean square error (RMSE), correlation coefficient

(R) can be defined to evaluate error indicators in the training and testing stages [22]:

$$MAE = \frac{\sum_{i=1}^N |P_i - O_i|}{N} \quad (10)$$

$$RMSE = \sqrt{\frac{1}{N} \sum_{i=1}^N (P_i - O_i)^2} \quad (11)$$

$$R = \frac{\sum_{i=1}^N (P_i - P_m)(O_i - O_m)}{\sqrt{(\sum_{i=1}^N (P_i - P_m)^2) \sqrt{(\sum_{i=1}^N (O_i - O_m)^2)}}} \quad (12)$$

where O_i is the measured value, P_i stands for prediction values; N is the number of data points, O_m is the mean value for observations and P_m is the mean value of predictions [23].

The statistical results of the developed ANFIS, GA-ANFIS-GA, and PSO-ANFIS-PSO for training and testing stages are presented in Table 2. For the training stages, it can be found that the PSO-ANFIS-PSO model produced more accurate performance (R= 0.85, RMSE=0.56, and MAE=0.44), compared to the other developed models. In the testing stages, the PSO-ANFIS-PSO network also predicts the PGA parameter with more accurate performance (R= 0.85, RMSE=0.60, and MAE=0.46), compared to the other developed models. For more illustration, scatter plots between predicted and the observed PGA values for both training and testing stages by the developed models are indicated in Figs. 6 (b) and (b), respectively. As shown, the scatter between observed and predicted PGA values by the PSO-ANFIS-PSO model is less than the other developed model for both training and testing datasets. It should be noted that the accuracy of the developed ANFIS and GA-ANFIS-GA models is also remarkable and the performance of GA-ANFIS-GA model is more accurate than the ANFIS model.

Table 2: Results of performances for training and testing stages of developed models

Method	Subset	MAE	RMSE	R
ANFIS	Training	0.5332	0.6810	0.7901
	Testing	0.5312	0.6697	0.8081
GA-ANFIS-GA	Training	0.4844	0.6086	0.8367
	Testing	0.4884	0.6132	0.8418
PSO-ANFIS-PSO	Training	0.4439	0.5686	0.8569
	Testing	0.4688	0.6061	0.8519

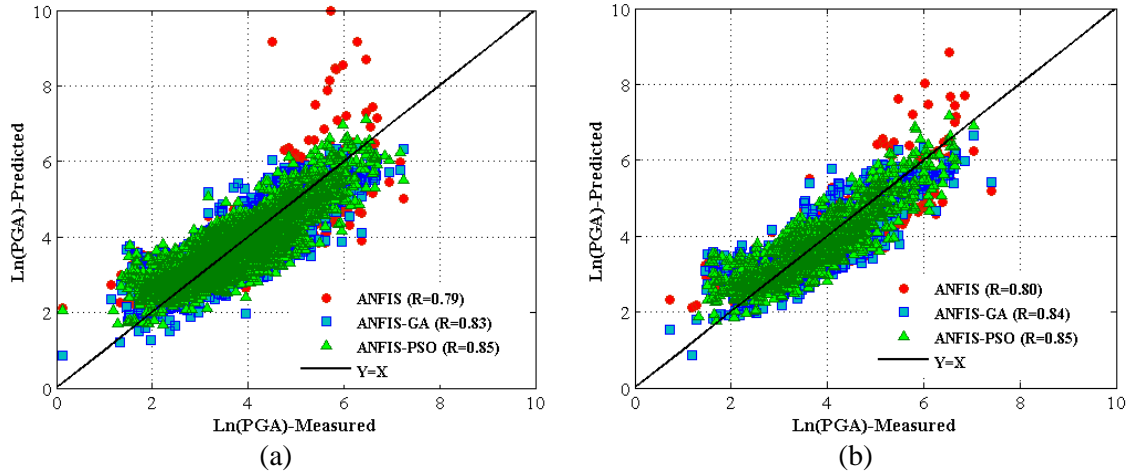

Figure 6. Scatter plots of observed and predicted PGA for (a) training (b) testing stages

Furthermore, performance of the developed models is also compared with some well-known soft computing based models including ANN-SA [10], GP [12], GP-SA [12], and M5' [13] algorithms. The results of statistical error parameters related to the mentioned models besides the developed models are presented in Table 2 for the entire database. As shown, the developed PSO-ANFIS-PSO model outperforms the mentioned models in terms of accuracy. The performances of GA-ANFIS-GA and M5' model are slightly the same, however, the GA-ANFIS-GA has better performance than the M5' and the other previous models. In general, the evolutionary based models developed in this study shows better predictive ability than other soft computing based models.

Table 2: the performance of different models.

Model	MAE	RMSE	R
ANFIS (Present study)	0.5326	0.6776	0.7956
GA-ANFIS-GA (Present study)	0.4856	0.6100	0.8382
PSO-ANFIS-PSO (Present study)	0.4514	0.5801	0.8550
M5' [13]	0.4894	0.6214	0.8315
ANN-SA [10]	0.5309	0.6782	0.7955
GP-SA [12]	0.5596	0.6938	0.8191
GP [12]	0.5390	0.6758	0.7981

Kaveh et al. [13] stated that the errors of a predictive model should be independent of input variables for having a good predictive ability. Therefore, the ratios of the predicted PGA parameter to observed values for different developed models with respect to the F , M_w , $\ln(R)$, and $V_{s,30}$ are shown in Fig. 7. As the scattering increases in this figure, the accuracy of the model will consequently decrease. It can be observed from these figures that the predictions obtained by the PSO-ANFIS-PSO model is more accurate with less significant trend with respect to the input parameters. It should be noted that the developed ANFIS and GA-ANFIS-GA models have also no significant trend with respect to the input variables.

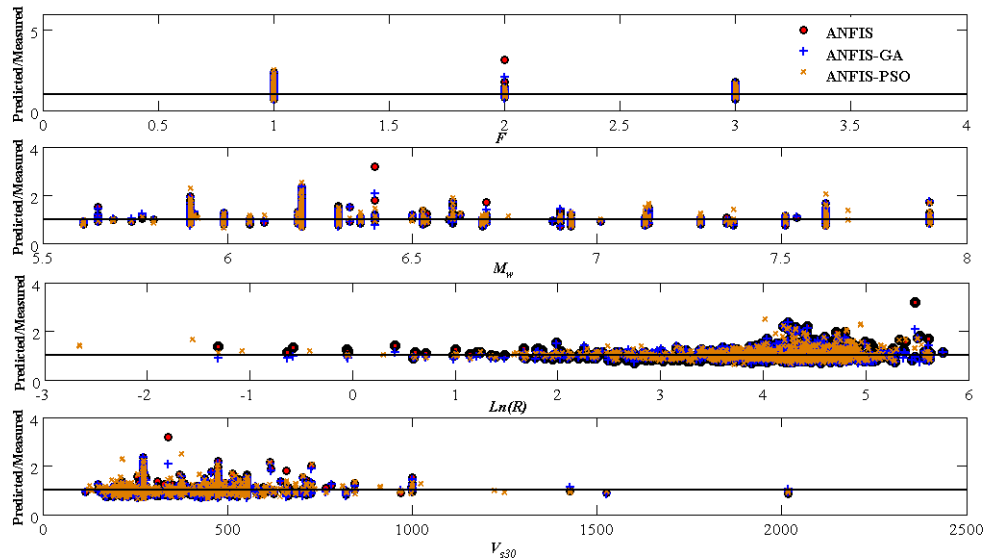

Figure 7. The ratio between the predicted and observed PGA values with respect to input variables

At final step, the most important parameters in prediction of the PGA parameter are determined by applying the gamma test (GT) analysis. In the GT analysis, the relationship between predictor and response variables can be detected without any need to generate a new predictive model. It estimates the minimum mean square error (MSE) that should be obtained by any smooth nonlinear function. More details about the GT analysis can be found in Kaveh et al. [24]. The most important parameters in GT analysis, which can be estimated, are gamma, gradient, standard error, and V_{ratio} . To determine the most effective input parameters for predicting the PGA parameter, five scenarios are considered. In first scenario, all input parameters were considered in GT analysis. In next step, the input variables are excluded one by one from the dataset in the remaining scenarios and then a new GT analysis is done. The results of GT analysis related to each scenarios are illustrated in Fig. 8.

In fact, removing each input variable from the analysis leads to change of GT parameters, which can be used to evaluate the importance of that excluded parameter. More changes in GT values indicate that the corresponding excluded parameter has more contribution in prediction of the PGA parameter. As shown in Fig. 7, the scenario 1, in which all input parameters are considered as effective parameters, has minimum values of GT parameters. According to this figure, removing $Ln(R)$ leads to a significant increase in GT parameters; therefore, it can be concluded that this parameter is the most effective parameters in prediction of the PGA parameters. The M_w , $V_{s,30}$, and F parameters are the other important parameters, respectively. These observations are in line with the results of previous studies (e.g. [10, 13]).

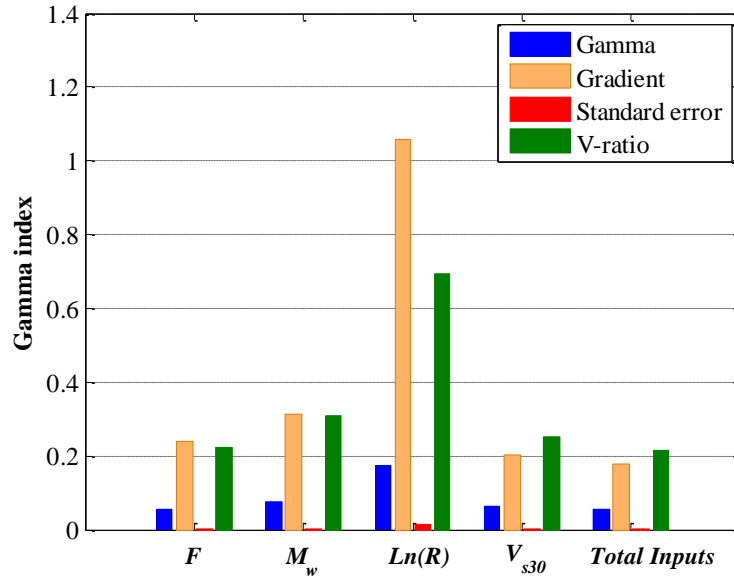

Figure 8. The results of GT analysis

4. CONCLUSION

In the present study, two hybrid approaches based on ANFIS framework which optimized with PSO and GA algorithms, are proposed to predict the peak ground acceleration (PGA). Two type parameters related to structure of ANFIS model including antecedent and consequent parameters are tuned through searching mechanism of PSO and GA algorithms. The applications of the developed PSO-ANFIS-PSO and GA-ANFIS-GA in field of earthquake engineering are both novel and effective. A relatively big database from Pacific Earthquake Engineering Research Center (PEER) are applied to develop hybrid models. Four common predictive parameters including earthquake magnitude, earthquake source to site distance, average shear-wave velocity, and faulting mechanisms are considered. The performance analysis indicates that the PSO-ANFIS-PSO and GA-ANFIS-GA showed acceptable improvement in accuracy in comparison with the developed ANFIS model. Furthermore, the comparison between two developed hybrid models revealed that the PSO-ANFIS-PSO model was more successful and produced more reliable predictions than the GA-ANFIS-GA model. The results of developed model are also compared with some common soft computing based models available in the literature. Results showed that the developed PSO-ANFIS-PSO outperforms the existing models. At final step, the most effective parameters in prediction of the PGA parameter are determined through the Gamma Test (GT) analysis. The $Ln(R)$, M_w , $V_{s,30}$, and F parameters are the most important parameters in prediction of the PGA parameter, respectively. In general, the findings of this paper reveal that the hybrid algorithms such as PSO-ANFIS-PSO and GA-ANFIS-GA are efficient and useful techniques for PGA prediction.

REFERENCES

1. Thomas S, Pillai GN, Pal K, Jagtap P. Prediction of ground motion parameters using randomized ANFIS (RANFIS), *Appl Soft Comput* 2016; **40**: 624-34.
2. Campbell KW, Bozorgnia Y. NGA ground motion model for the geometric mean horizontal component of PGA, PGV, PGD and 5% damped linear elastic response spectra for periods ranging from 0.01 to 10 s, *Earthq Spect* 2008; **24**(1): 139-71.
3. Campbell KW, Bozorgnia Y. Campbell-Bozorgnia NGA ground motion relations for the geometric mean horizontal component of peak and spectral ground motion parameters, Pacific Earthquake Engineering Research Center, 2007.
4. Campbell KW, Bozorgnia Y. NGA-West2 ground motion model for the average horizontal components of PGA, PGV, and 5% damped linear acceleration response spectra, *Earthq Spect* 2014; **30**(3): 1087-15.
5. Douglas J. *Ground-motion prediction equations 1964-2010*, Pacific Earthquake Engineering Research Center Berkeley, CA, 2011
6. Douglas J. Earthquake ground motion estimation using strong-motion records: a review of equations for the estimation of peak ground acceleration and response spectral ordinates, *Earth Sci Rev* 2003; **61**(1): 43-104.
7. Kerh T, Ting S. Neural network estimation of ground peak acceleration at stations along Taiwan high-speed rail system, *Eng Appl Artif Intell* 2005; **18**(7): 857-66.
8. Güllü H, Erçelebi E. A neural network approach for attenuation relationships: An application using strong ground motion data from Turkey, *Eng Geol* 2007; **93**(3): 65-81.
9. Gandomi AH, Alavi AH, Mousavi M, Tabatabaei SM. A hybrid computational approach to derive new ground-motion prediction equations, *Eng Appl Artif Intell* 2011; **24**(4): 717-32.
10. Alavi AH, Gandomi AH. Prediction of principal ground-motion parameters using a hybrid method coupling artificial neural networks and simulated annealing, *Comput Struct* 2011; **89**(23): 2176-94.
11. Alavi AH, Gandomi AH, Modaresnezhad M, Mousavi M. New ground-motion prediction equations using multi expression programming, *J Earth Eng* 2011; **15**(4): 511-36.
12. Mohammadnejad AK, Mousavi AK, Torabi SM, Mousavi M, Alavi AH. Robust attenuation relations for peak time-domain parameters of strong ground motions. *Environ Earth Sci* 2012; **67**(1): 53-70.
13. Kaveh A, Bakhshpoori T, Hamze-Ziabari SM. Derivation of New Equations for Prediction of Principal Ground-Motion Parameters using M5' Algorithm, *J Earth Eng*, 2016; **20**(6): 910-30.
14. Thomas S, Pillai G, Pal K. Prediction of peak ground acceleration using ϵ -SVR, ν -SVR and Ls-SVR algorithm, *Geomatics, Natural Hazards and Risk* 2016; 1-17.
15. Jang JS. ANFIS: adaptive-network-based fuzzy inference system, *IEEE Trans Syst Man Cybern* 1993; **23**(3): 665-85.
16. Holland JH. *Adaptation in Natural and Artificial Systems: an Introductory Analysis with Applications to Biology, Control, and Artificial Intelligence*, MIT press, 1992.
17. Kennedy JF, Kennedy J, Eberhart RC, Shi Y. *Swarm intelligence*, Morgan Kaufmann, 2001.

18. Kaveh A, Bakhshpoori T. Water Evaporation Optimization: A novel physically inspired optimization algorithm, *Comput Struct* 2016; **167**: 69-85.
19. Goldberg DE, Holland JH. Genetic algorithms and machine learning, *Mach Learn* 1988; **3**(2): 95-99.
20. Gonçalves JF, Mendes JJ, Resende MG. A genetic algorithm for the resource constrained multi-project scheduling problem, *Eur J Oper Res* 2008; **189**(3): 1171-90.
21. Kaveh A, Bakhshpoori T, Afshari E. An efficient hybrid particle swarm and swallow swarm optimization algorithm. *Comput Struct* 2014; **143**: 40-59.
22. Kaveh A, Hamze-Ziabari SM, Bakhshpoori T. M5' Algorithm for Shear Strength Prediction of HSC Slender Beams without Web Reinforcement, *Int J Model Optim* 2017; **7**(1): 48-53.
23. Kaveh A, Hamze-Ziabari SM, Bakhshpoori T. Patient rule-induction method for liquefaction potential assessment based on CPT data, *Bull Eng Geol Environ* 2016; 1-17.
24. Kaveh A, Bakhshpoori T, Hamze-Ziabari SM. New model derivation for the bond behavior of NSM FRP systems in concrete. *Iranian J Sci Tech* 2017; Accepted.