

OPTIMIZATION OF VERTICAL ALIGNMENT OF HIGHWAYS IN TERMS OF EARTHWORK COST USING COLLIDING BODIES OPTIMIZATION ALGORITHM

A.R. Ghanizadeh^{1*},[†] and N. Heidarabadizadeh²

¹*Department of Civil Engineering, Sirjan University of Technology, Sirjan, Iran*

ABSTRACT

One of the most important factors that affects construction costs of highways is the earthwork cost. On the other hand, the earthwork cost strongly depends on the design of vertical alignment or project line. In this study, at first, the problem of vertical alignment optimization was formulated. To this end, station, elevation and vertical curve length in case of each point of vertical intersection (PVI) were considered as decision variables. The objective function was considered as earthwork cost and constraints were assumed as the maximum and minimum grade of tangents, minimum elevation of compulsory points, and the minimum length of vertical curves. For solving this optimization problem, the Colliding Bodies Optimization (CBO) algorithm was employed and results were compared with Genetic Algorithm (GA) and Particle Swarm Optimization (PSO). In order to evaluate the effectiveness of formulation and CBO algorithm, three different highways were designed with respect to three different terrains including level, rolling and mountainous. After designing the preliminary vertical alignment for each highway, the optimal vertical alignments were determined by different optimization algorithms. The results of this research show that the CBO algorithm is superior to GA and PSO. Percentage of optimality (saving in earthworks cost) by CBO algorithm for level, rolling and mountainous terrains was determined as 44.14, 21.42 and 22.54%, respectively.

Keywords: optimization; vertical alignment; earthworks cost; colliding bodies optimization (CBO).

Received: 10 January 2018; Accepted: 7 March 2018

1. INTRODUCTION

Geometric design of highway is consisted of four main stages including design of horizontal

*Corresponding author: Department of Civil Engineering, Sirjan University of Technology, Sirjan, Iran

[†]E-mail address: ghanizadeh@sirjantech.ac.ir (A.R. Ghanizadeh)

alignment, design of vertical alignment, design of cross sections, and estimation of earthwork volumes. After design of horizontal alignment, the vertical alignment is the most important factor that affects the earthwork cost. Several published works proposed that the vertical alignment should be as closely as possible to the ground line [1–5]. In contrary, some references consider other factors such as minimizing earthwork and balancing cut-fill along with the existing ground elevation, for designing the vertical alignment [6,7].

In order to reduce the construction cost of highway, a mathematical model must be developed for optimization of vertical alignment. In addition to the minimizing the earthwork cost, the optimum vertical alignment must be able to consider constraints such as maximum and minimum allowable grades, the minimum length of vertical curves, and elevation of compulsory points.

With the help of computers and appropriate mathematical models, highway engineers are able to fulfill the designing process in significant speed and to achieve an optimum solution. The optimal solution obtained from mathematical models and computer applications can result in considerable saving in construction costs in comparison with traditional design.

Until now, many researchers have tried to optimize the vertical alignment of highways and railways. Easa (1988) developed a model to find the elevation of a vertical alignment at fixed intervals that minimizes earthwork. Three constraints, including critical length of grade lines, fixed elevation points, and non-overlapping of horizontal and vertical curves were considered in his research [8]. Dabbour et al. (2002) proposed a model for optimization of vertical curve using nonlinear programming. They defined the objective function as the difference between vertical alignment and existing ground profile. In addition, they considered maximum allowable grade, maximum vertical curvature and non-overlapping of vertical curves as constraints [9].

Fwa et al. (2002), proposed a model for optimization of vertical alignment by means of genetic algorithm. They consider three constraints including critical length of grade lines, fixed-elevation points, and non-overlapping of horizontal and vertical curves. Results showed that these three constraints have significant effects on the computed optimal alignments and the associated construction costs [10]. Goktepe and Lav (2003) proposed a hypothetical weighted ground elevation concept to balance cut-fill volumes and to minimize total amount of earthwork. In the suggested method, the integration of weighted ground elevations along the centerline defines a hypothetical reference ground line to determine optimum grades of vertical alignment [11]. This method then was modified to consider some soil properties essential for an accurate earthwork optimization [12]. Soknath and Piantanakulchai (2010) suggest polynomial regression model to find the vertical alignment, that provides the sense of minimizing earthwork volume and also balancing cut and fill. They also proposed two algorithms to handle the design constraints [13]. Goktepe et al. (2008) used fuzzy decision support system for choosing swelling and shrinkage factors affecting the precision of earthwork optimization [14].

Bababeik and Monajjem (2012) proposed a model to find the best vertical alignment for a railway with a given horizontal alignment based on construction and operation costs. They employed the direct search method along with genetic algorithm for solving this optimization problem [15].

Hare et al. (2015), presented a mixed integer linear programming model for the vertical

alignment problem that considers the side-slopes of the road and the natural blocks like rivers, mountains, etc., in the construction area. The numerical results showed that the model with regard to the cutting and filling slopes, can provide the suitable responses without significantly increasing in time [16].

Existing models, despite good performance, still have many deficiencies and have not been widely used in the real world. Therefore, an appropriate model as well as an efficient algorithm with appropriate run time is still needed to optimize highway alignment.

The main goal of this study is to present an optimization model to determine the optimum vertical alignment in terms of minimizing earthwork cost. Generally, in most past researches, objective function has been considered as the sum of the absolute value of difference between the vertical alignment and the existing ground. In addition, the modern optimization algorithms which need no tuning parameters, did not take into account in past researches. In this research, the objective function has been considered as the cost of earthwork which needs accurate computation of earthwork based on prismatic method. Also in the present study, the colliding bodies optimization algorithm was employed in order to solve the problem of vertical alignment optimization and performance of these models were compared with each other.

2. COLLIDING BODIES OPTIMIZATION (CBO) ALGORITHM

Methods of optimization can be divided into two general categories including Mathematical methods and Meta-heuristic algorithms. Mathematical methods are hard to apply especially in practical engineering problems. Furthermore, they require a good starting point to successfully converge to the optimum and may be trapped in local optima [17]. In contrary, Meta-heuristic algorithms used to solve wide range of problems in civil engineering [18–25]. Most of Meta-heuristic algorithms such as Genetic algorithms (GA) [26], Particle swarm optimization (PSO) [27], Ant colony optimization (ACO) [28], Charged system search (CSS) [29], Fire Fly Algorithms (FFA) [30], and Dolphin echolocation (DE) [31] have different setting parameters and a tuning process is often required to determine these parameters. A meta-heuristic algorithm is usually tuned for a specific problem and there is no guarantee for using these parameters in case of other problems or situations.

Colliding Bodies Optimization (CBO) is a relatively new metaheuristic optimization algorithm which has been developed by [32]. This algorithm is simple for implementation and it has no internal parameter for tuning. In this algorithm, one object collides with other object and these two objects move towards a minimum energy level. Each colliding body (CB), X_i , has a specified mass which is defined as follows:

$$m_k = \frac{\frac{1}{fit(k)}}{\sum_{i=1}^n \frac{1}{fit(i)}} \quad k = 1, 2, \dots, n \quad (1)$$

where $fit(i)$ denotes the objective function value of the i th CB and n is the number of colliding bodies. In order to select pairs of objects for collision, CBs are sorted according to their mass in a decreasing order and they are divided into two equal groups including stationary group and moving group (Fig. 1). Moving objects collide to stationary objects to improve their positions and push stationary objects towards better positions. The velocities of the stationary and moving bodies before collision (v_i) are computed by Equation (2) and (3), respectively.

$$v_i = 0 \quad i = 1, 2, \dots, \frac{n}{2} \tag{2}$$

$$v_i = x_{i-\frac{n}{2}} - x_i \quad i = \frac{n}{2} + 1, \frac{n}{2} + 2, \dots, n \tag{3}$$

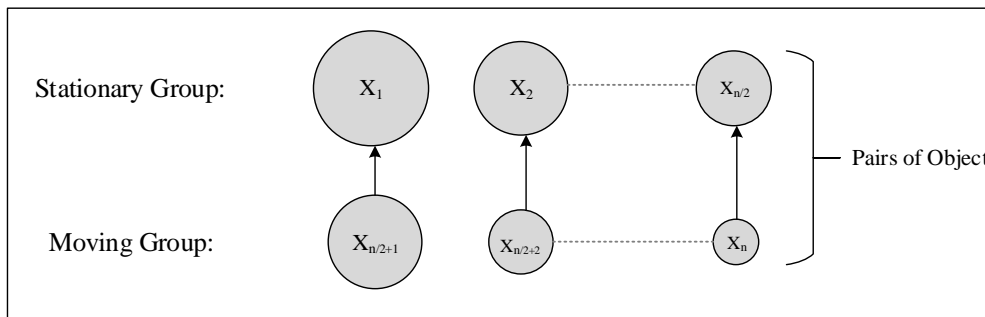

Figure 1. Bodies pairs for collision

The velocity of stationary and moving CBs after the collision (v'_i) are estimated by Equation (4) and (5), respectively.

$$v'_i = \frac{\left(m_{i+\frac{n}{2}} + \varepsilon m_{i+\frac{n}{2}} \right) v_{i+\frac{n}{2}}}{m_i + m_{i+\frac{n}{2}}} \quad i = 1, 2, \dots, \frac{n}{2} \tag{4}$$

$$v'_i = \frac{\left(m_i - \varepsilon m_{i-\frac{n}{2}} \right) v_i}{m_i + m_{i-\frac{n}{2}}} \quad i = \frac{n}{2} + 1, \frac{n}{2} + 2, \dots, n \tag{5}$$

$$\varepsilon = 1 - \frac{iter}{iter_{max}} \tag{6}$$

where $iter$ and $iter_{max}$ are the current iteration number and the total number of iteration for optimization process, respectively. ε is the coefficient of restitution (COR). New positions of each CB can be updated as follows:

$$x_i^{new} = x_i + rand \circ v_i' \quad i = 1, 2, \dots, \frac{n}{2} \quad (7)$$

$$x_i^{new} = x_{i-\frac{n}{2}} + rand \circ v_i' \quad i = \frac{n}{2} + 1, \frac{n}{2} + 2, \dots, n \quad (8)$$

where x_i^{new} , x_i and v_i' are the new position, previous position and the velocity after the collision of the i th CB, respectively. Rand is a random vector uniformly distributed in the range of $[-1,1]$ and the sign “ \circ ” denotes an element-by-element multiplication [33]. The flowchart of CBO algorithm is represented in Fig. 2.

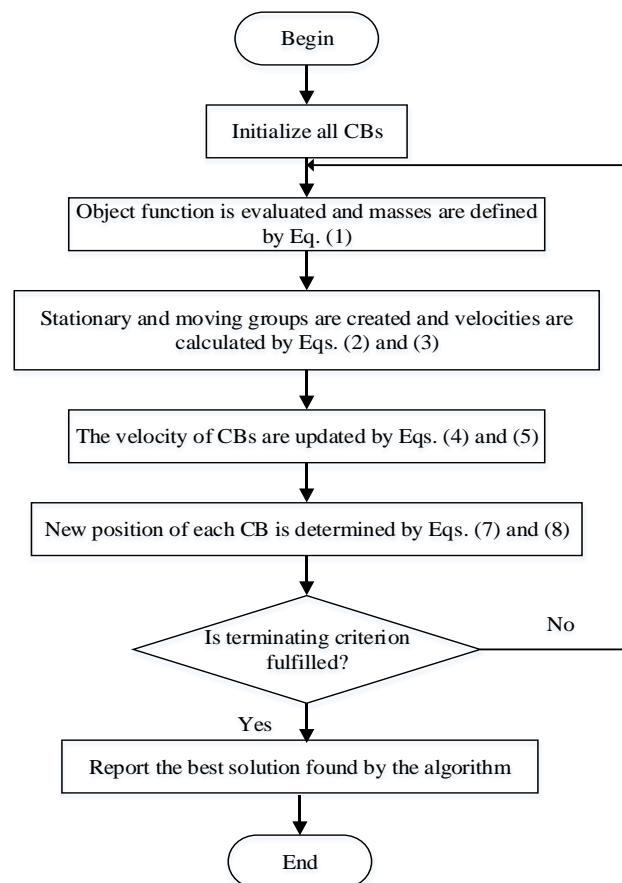

Figure 2. The flowchart of CBO algorithm [33]

3. MATHEMATICAL MODEL FOR OPTIMIZATION OF VERTICAL ALIGNMENT

Fig. 3 shows schematic view of a longitudinal profile for a highway. In this figure, the dashed line represents the existing ground and the solid line represents the finished ground or vertical alignment of highway. Vertical alignment consists of several PVIs and each PVI

can be defined by three parameters of x_{PVI}^i , y_{PVI}^i , and L_{PVI}^i , where these three parameters are station, elevation and vertical curve length for i^{th} PVI, respectively. The length of vertical curve, L_{PVI}^i , in case of $i=1$ and $i=n$ is zero. Station, elevation and minimum required height for i^{th} compulsory point are indicated by x_{cp}^i , y_{cp}^i and h_{cp}^i , respectively.

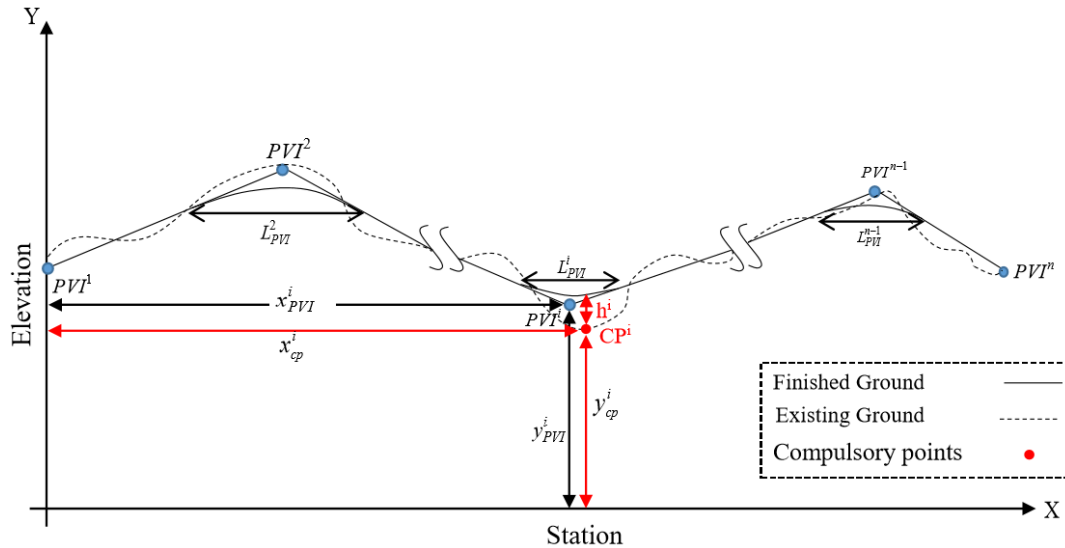

Figure 3. Longitudinal profile of the road

3.1 The objective function

The objective function (minimization of earthwork cost) is considered as follows:

$$Min \quad f = \delta_1 \times C_c \times V_c + \delta_2 \times C_f \times V_f + (C_r + C_f) \times h \times AL_f + C_p \times AL_c \quad (9)$$

where, f is the earthworks cost; δ_1 is the swelling factor; δ_2 is the shrinkage factor; V_c and V_f are cutting and filling volume in m^3 ; AL_f is the bed area between two consecutive sections that place in the fill in m^2 ; AL_c is the area of cutting slopes between two consecutive sections that place in the cut in m^2 ; h is the thickness of the vegetable soil; C_c is the unit cutting cost per m^3 ; C_f is the unit filling cost per m^3 ; C_r is the unit cost of vegetable soil removing per m^3 , and C_p is the unit cost of cutting slopes profiling per m^2 .

The value of bed area between two consecutive fill cross-sections (AL_{ij}^f) is necessary for computation of vegetable soil volume, which should be removed and replaced by the controlled fill materials. On the other hand, the area of cutting slopes between two consecutive cut cross-sections (AL_{ij}^c) affects the profiling cost of cutting grades. These two parameters are represented in Fig. 4.

In order to calculate the earthwork volume, the fill and cut area for each cross section should be computed and after that the fill and cut volume can be computed in terms of

distance between two consecutive sections using prismatic formula. In this research, the coordinate method was employed for computation of fill and cut areas for each section. An example of how to calculate the cutting surface using coordinate method has been presented in Fig. 5, where, the coordinate of i^{th} point is indicated by x_i and y_i .

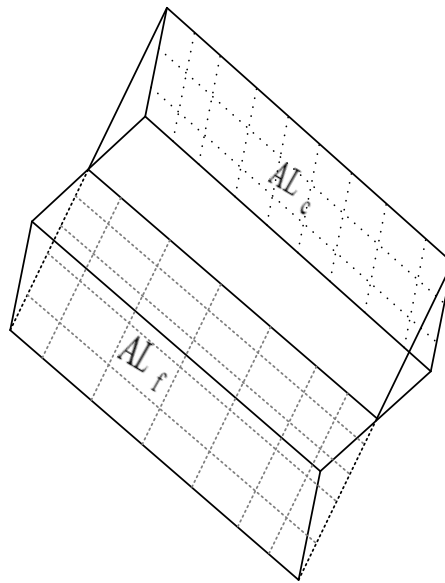

Figure 4. AL_f and AL_e

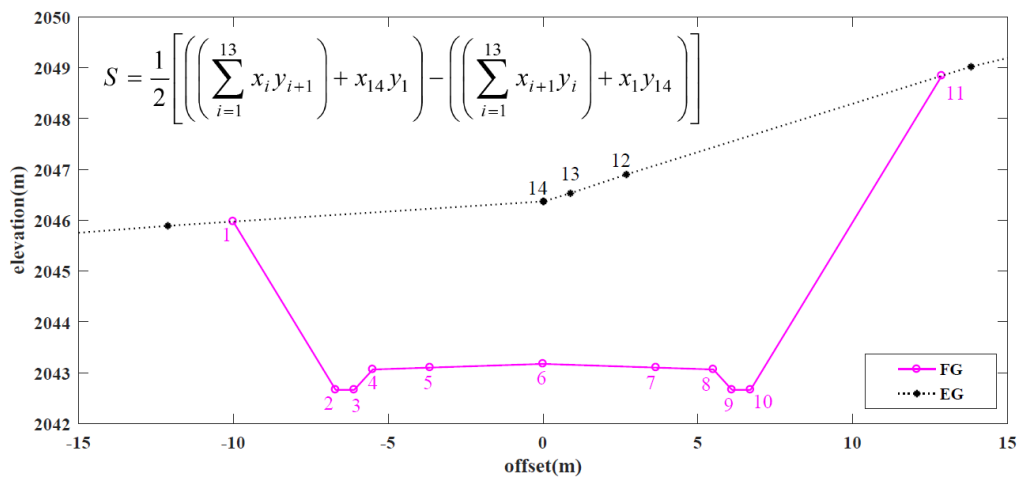

Figure 5. An example for computation of cutting area using coordinate method

According to prismatic formula, the earthwork volume between two consecutive sections can be computed as follows:

$$V = \left(\frac{A_1 + A_2 + \sqrt{A_1 A_2}}{3} \right) L \tag{10}$$

where V is the volume between two consecutive sections; A_1 is the area of the first section; A_2 is the area of the second section, and L is the horizontal distance between two consecutive sections. Depending on the fill and cut conditions between two consecutive sections, the volume can be calculated according to one of the six cases presented in Fig. 6. In this figure, V_f is the fill volume; V_c is the cut volume, A_f is the fill area; A_c is the cut area, and L is the horizontal distance between two consecutive sections.

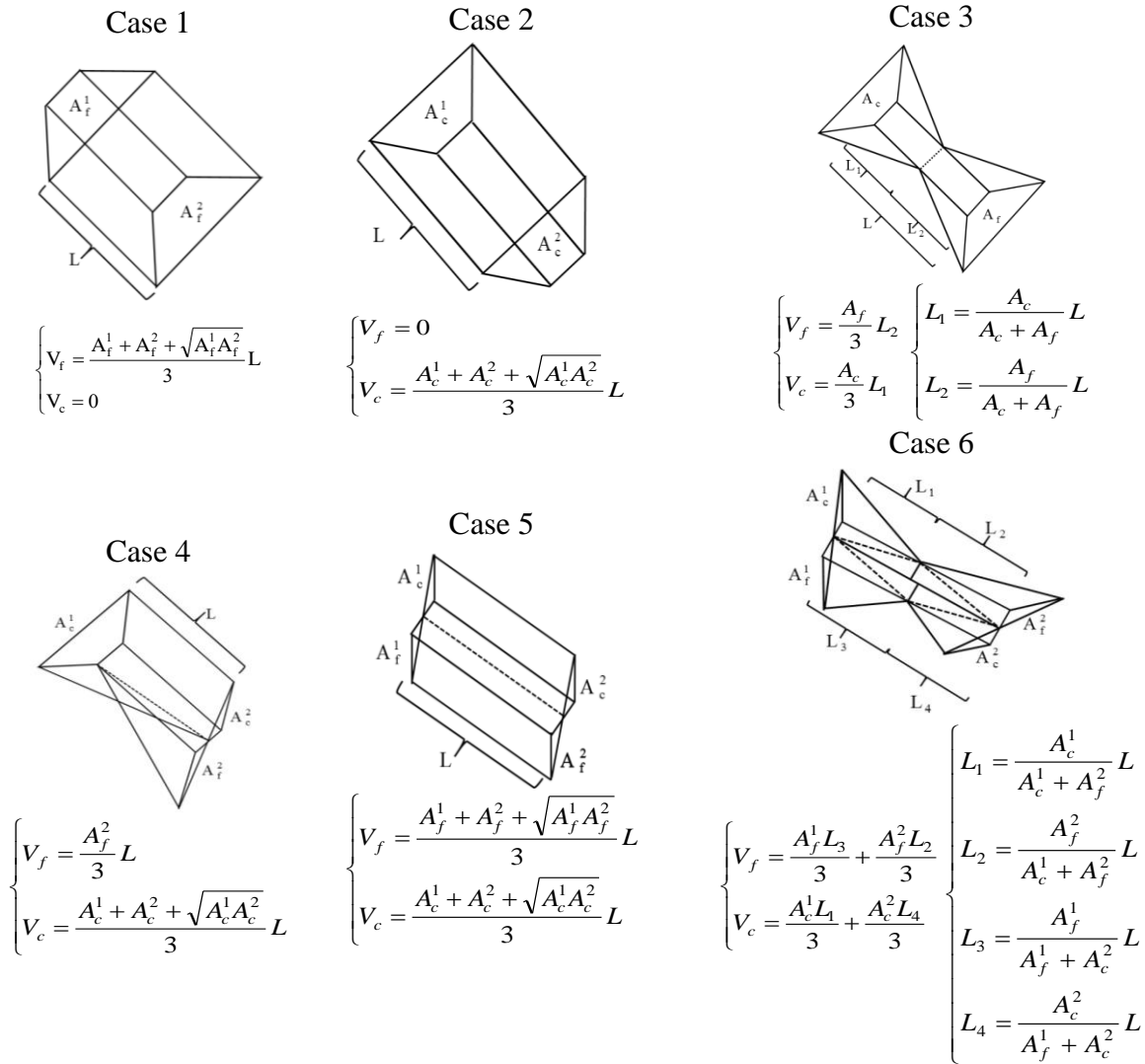

Figure 6. Computation of fill and cut in terms of fill and cut conditions

3.2 Constraints

3.2.1 Maximum and minimum grade of tangents

Maximum and minimum grade of tangent lines are mainly controlled by topography of land, highway classification, the traction power of heavy vehicles, safety, construction costs,

drainage considerations, and landscape layout [34, 6]. Grade of tangent lines should not exceed its minimum and maximum values as follows:

$$g_{\min} \leq g^i = \frac{y_{PVI}^{i+1} - y_{PVI}^i}{x_{PVI}^{i+1} - x_{PVI}^i} \leq g_{\max} \quad i = 1, 2, 3, \dots, n-1 \quad (11)$$

where g_{\min} denotes the minimum allowable grade of tangents, and g_{\max} denotes the maximum allowable grade of tangents. Other parameters are represented in Fig. 3.

3.2.2 Minimum length of vertical curves

Changing of grade is done gradually by a vertical curve. This vertical curve will provide sufficient sight distance, proper drainage of surface water, safety, driver comfort and apparent aesthetic of highway. The minimum length of vertical curves is controlled by the minimum sight distance needed for safe driving [34, 6]. Vertical curve length must satisfy the following equation:

$$L_{PVI}^i \geq K \times A_{PVI}^i \quad i = 2, 3, n-1 \quad (12)$$

where, L_{PVI}^i is the length of vertical curve at i^{th} PVI; A_{PVI}^i is the absolute algebraic difference between intersecting tangent grades at i^{th} PVI; and K is the rate of change of grade at two successive points on the curve which is determined based on the design speed and the type of vertical curve (sag or crest).

3.2.3 Non-overlapping of two successive vertical curves

Increasing the length of vertical curves should be to the extent that there is no overlap between two successive vertical curves to keep the continuity of vertical alignment. This constraint can be expressed as follows:

$$\left(x_{PVI}^{i+1} - x_{PVI}^i \right) \geq \left(\frac{L_{PVI}^{i+1} + L_{PVI}^i}{2} \right) \quad i = 1, 2, \dots, n-1 \quad (13)$$

where x_{PVI}^i and L_{PVI}^i are represented in Fig. 3.

3.2.4 Compulsory points

Compulsory points are commonly encountered in design of vertical alignment. For example, the elevation of the start and endpoint of a new road are typically fixed. Intermediate compulsory points are needed where a new road intersects existing roads. In this study, bridges were considered as compulsory points with fixed station and a minimum value for the elevation. According to the hydrological studies, station and minimum free height of bridges can be determined. The minimum elevation of vertical alignment at the bridge's

station is equal to elevation of ground point at that station plus the free height of bridge.

4. COMPUTER CODE FOR COMPUTATION OF VERTICAL ALIGNMENT AND EARTHWORK VOLUMES

In order to compute the earthwork volumes accurately, a computer code was developed using MATLAB program. This code is made up of four subroutines.

In the first subroutine, station, elevation and length of vertical curve for each PVI as well as station and elevation of existing ground points are imported from a text file and then the elevation of each point on the vertical alignment corresponding with the existing ground station is calculated.

In the second subroutine, the fill and cut area for each cross section are computed based on the typical cross-section of the road and existing ground points (offsets and elevations) at each cross-section. Parameters that control typical cross-section include travelway wide, shoulder wide, slope of travelway, slope of shoulder, cutting slope, filling slope, trench depth and trench wide.

In the third subroutine, the volume of vegetable soil is computed based on the thickness of vegetable soil, and then the value of bed area between two consecutive fill cross-sections (AL_{ij}^f) and the area of cutting grades between two consecutive cut cross-sections (AL_{ij}^c) is computed.

Finally in the fourth subroutine, fill and cut volumes are computed based on the perismoidal method.

One of the most well-known software in the field of highway geometric design is AutoCAD Land Desktop which has been developed by Autodesk, Inc. In order to validate the obtained results of the developed MATLAB code, earthwork volumes for three different highways, were calculated once by using the developed code and once again by using the AutoCAD Land Desktop software. Results are given in Table 1.

Table 1: Comparison of earthworks computed by AutoCAD Land Desktop and developed Code

Earthwork type	Method	Topography of highway		
		level	rolling	mountainous
Cut volume (m ³)	AutoCAD Land Desktop	2056.21	550845.33	277.82
	Developed Code	2002.97	547963.94	263.43
	Difference (%)	2.59	0.53	5.17
Fill volume (m ³)	AutoCAD Land Desktop	80539.69	154396.7	92150.09
	Developed Code	80317.97	153395.99	91346.86
	Difference (%)	0.28	0.65	0.87

As it can be seen, earthwork volumes computed by the developed code and the AutoCAD Land Desktop are very close. The maximum difference between the volumes computed by the developed code and the AutoCAD Land Desktop is 5.17% which confirms the high accuracy of developed code in terms of computations of earthwork volumes.

5. NUMERICAL EXAMPLES

5.1 Problem statement

In order to evaluate the proposed formulation and testing performance of different optimization algorithms, three highways were designed in three different terrains including level, rolling and mountainous. Geometric design criteria for each terrain are given in Table 2.

Table 2: Geometric design criteria for highways designed in level, rolling and mountainous terrains

Design Parameters	level	rolling	mountainous
Classification of highway	Major road	Major road	Major road
Designing speed (km/h)	110	100	100
length of alignment (m)	6993.17	6999.95	5356.76
Road width (m)	11	11	11
The number of compulsory points	9	4	7
The number of PVI's	9	11	8
The number of decision variables	21	27	18
The maximum grade of tangents (%)	3	5	6
The minimum grade of tangents (%)	0	0.3	0.3
K value for sag vertical curves	74	52	52
K value for crest vertical curves	55	45	45
The minimum free height of bridges (m)	0.4	2	1.5

Table 3: Assumed values of parameters for computation of earthwork cost

Parameters	Value
h (m)	0.2
C_c ($\$/m^3$)	0.289
C_f ($\$/m^3$)	0.356
C_r ($\$/m^3$)	0.120
C_p ($\$/m^2$)	0.055

Given the horizontal alignments of these three highways, the longitudinal profile of each road was sampled by AutoCAD Land Desktop software, and the initial vertical alignment was designed with respect to constraints by a geometric design expert. After that the preliminary designed vertical alignment (station and elevation of PVI's as well as the length of vertical curves in each PVI) and existing ground points for different cross-sections were exported to a text file. This text file was the input file for Matlab optimization code.

5.2 Setting GA and PSO parameters

For comparison of CBO algorithm with other well-known optimization algorithms to find the optimum vertical alignment, genetic algorithm and particle swarm optimization were selected for further study.

In the genetic algorithm (GA), range of cross-probability change and range of mutation probability change was considered as [0.7-1] and [0.1-0.4], respectively. In order to

determine the optimum values of these two parameters, try and error method was employed with 50 populations and 2000 iterations. The best value for cross-probability and mutation probability was determined as 0.9 and 0.4, respectively.

The particle swarm optimization (PSO) algorithm has three design parameters of α , β and γ . In order to determine the optimum values of these three parameters, the range of α , β and γ parameters were considered as [0.4-0.1], [0.7- 0.1] and [0.97-0.9], respectively. Again, try and error method was employed with 50 populations and 2000 iterations and results showed that the best value for α , β and γ is 0.2, 0.6 and 0.96, respectively.

5.3 Results and discussion

The number of initial population in case of GA, PSO and CBO algorithms was assumed as 50 and for comparison of different optimization algorithms, the iteration was set to 2000. Also the lower and upper bound for PVIs elevation was assumed as initial elevation of PVIs minus and plus 20m. The lower and upper bound for a specific PVI station was assumed as initial station of PVI minus and plus to half of distance from before and after PVIs. Constraints also were considered in optimization process by penalty method.

The initial as well as optimized earthwork cost for three highways are given in Tables 4, 5 and 6.

Table 4: Comparison of different parameters for initial and optimized vertical alignment in the level terrain

Parameter	Initial	GA	PSO	CBO
Earthwork cost (\$)	53354	45550	30561	29802
Cut cost (\$)	182	827	5984	5580
Fill cost (\$)	43278	35471	17914	17707
Cut volume (m ³)	627.6	2861.36	20712.72	19315.85
Fill volume (m ³)	121718.7	99761.63	50383.7	49800.71
The ratio of the fill to cut volume	193.9	34.87	2.43	2.58
Optimality percentage	-	14.63	42.72	44.14

Table 5: Comparison of different parameters for initial and optimized vertical alignment the rolling terrain

Parameter	Initial	GA	PSO	CBO
Earthwork cost (\$)	230570	209859	198792	181186
Cut cost (\$)	158301	119114	109846	102764
Fill cost (\$)	54541	81318	79574	69569
Cut volume (m ³)	547963.94	412318.4	380236.48	355721.37
Fill volume (m ³)	153395.99	228708.14	223800.32	195663.83
The ratio of the fill to cut volume	0.28	0.55	0.59	0.55
Optimality percentage	-	8.98	13.78	21.42

Table 6: Comparison of different parameters for initial and optimized vertical alignment in the mountainous terrain

Parameter	Initial	GA	PSO	CBO
Earthwork cost (\$)	40161	37848	31505	31109
Cut cost (\$)	76	515	2948	2411
Fill cost (\$)	32479	30081	22217	22286
Cut volume (m ³)	263.43	1783.28	10203.65	8346.5
Fill volume (m ³)	91346.86	84603.62	62484.55	62679.74
The ratio of the fill to cut volume	346.76	47.44	6.12	7.5
Optimality percentage	-	5.76	21.55	22.54

According to the obtained results in the three above tables, CBO algorithm obtains more optimum value in comparison with the PSO and GA algorithms in three topographies of level, rolling and mountainous. Figs. 7 to 9 show the ground line, the initial vertical alignment as well as the optimum vertical alignment using CBO algorithm in three different topographies of level, rolling and mountainous, respectively. The optimality percentage (difference between initial and optimum earthwork cost in percent) for CBO was obtained as 44.14, 21.42 and 22.54 in level, rolling and mountainous terrain, respectively. These values in case of GA algorithm were obtained as 14.63, 8.98, and 5.76 and 42.72, 13.78, and 21.55 in case of PSO algorithm in level, rolling and mountainous terrain, respectively.

One of the most interesting results of this research is that the minimum earthwork cost is obtained when there is a better balance between cut and fill volume. It can be seen that for initial vertical alignment in level, rolling and mountainous terrain, the ratio of the fill to cut volume is 193.9, 0.28 and 346.76 respectively. While these values decrease to 2.58, 0.55 and 7.5 for vertical alignments optimized with CBO algorithm.

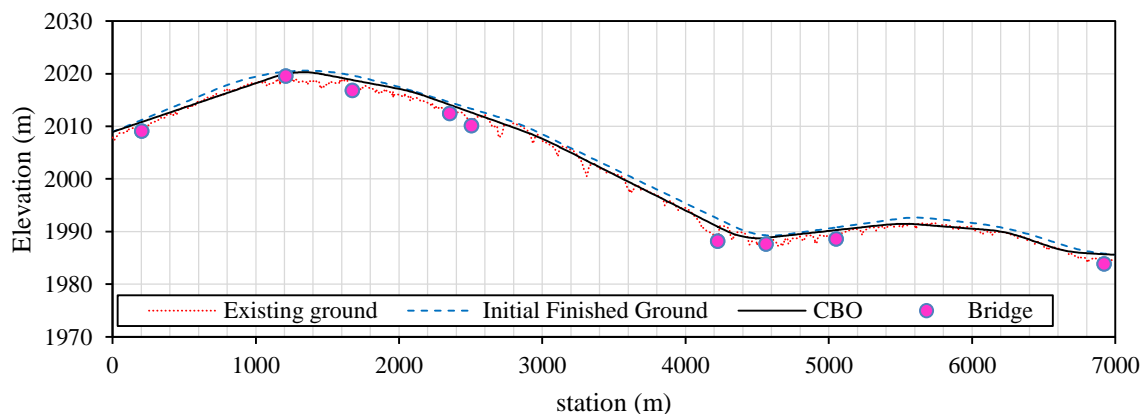

Figure 7. Longitudinal profile in case of highway designed in level terrain

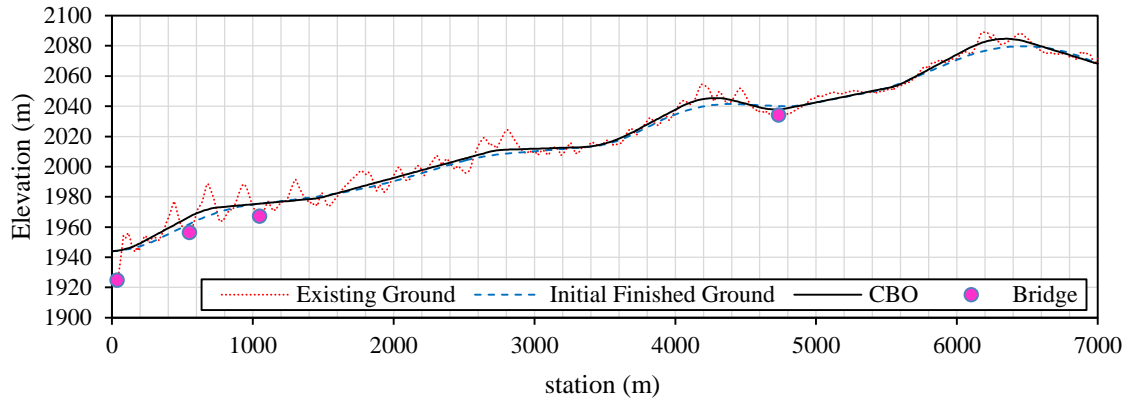

Figure 8. Longitudinal profile in case of highway designed in rolling terrain

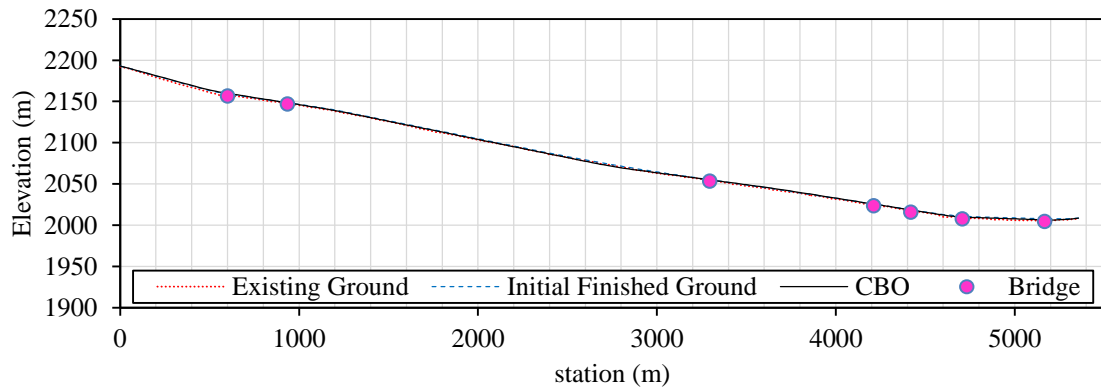

Figure 9. Longitudinal profile in case of highway designed in mountainous terrain

Figs. 10 to 12 show optimality graph of GA, PSO and CBO algorithms for three topographies of level, rolling and mountainous. It is evident that the GA and PSO methods are not able to find the global optimum solution and are trapped in local optima, while the CBO method is successful in finding the global optimum solution. In addition, the CBO method has no certain parameter for setting and tuning, while both GA and PSO methods have tuning parameters which significantly affect optimum solution as well as performance of algorithm.

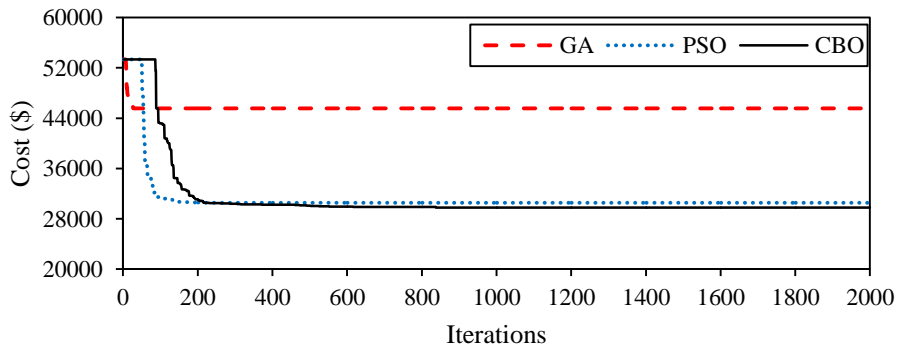

Figure 10. Performance of different algorithms to find optimum solution (level terrain)

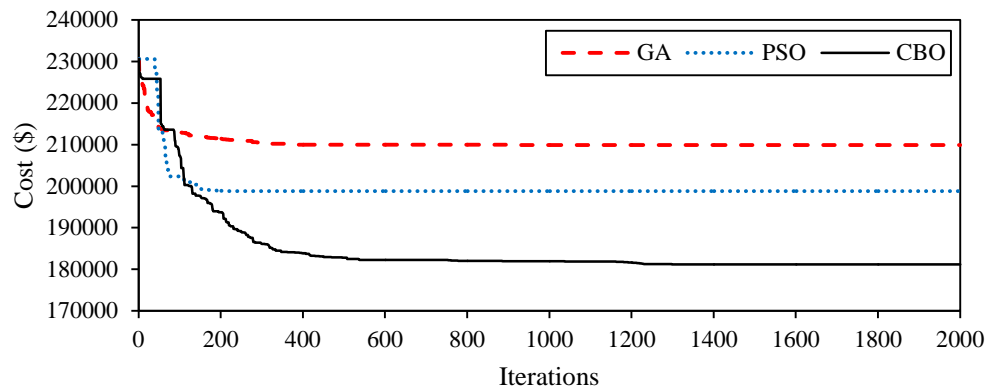

Figure 11. Performance of different algorithms to find optimum solution (rolling terrain)

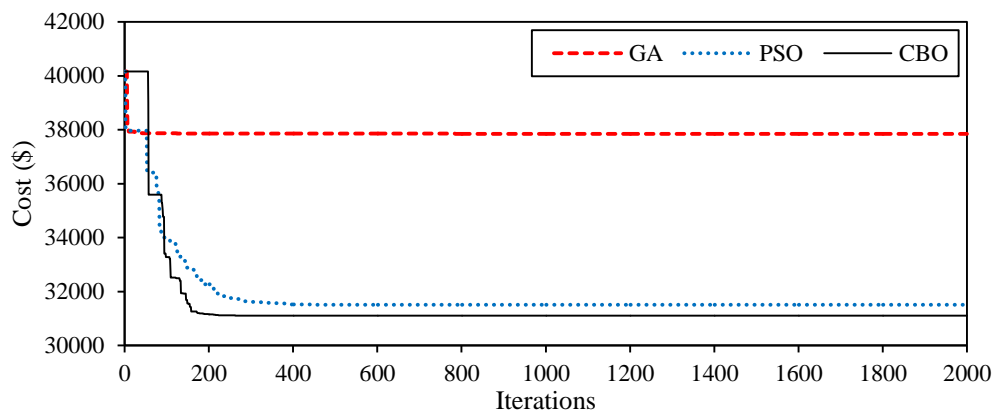

Figure 12. Performance of different algorithms to find optimum solution (mountainous terrain)

In order to assess the performance of different algorithms, run time for each iteration and the latest optimum iteration are presented in Figs. 13 and 14, respectively.

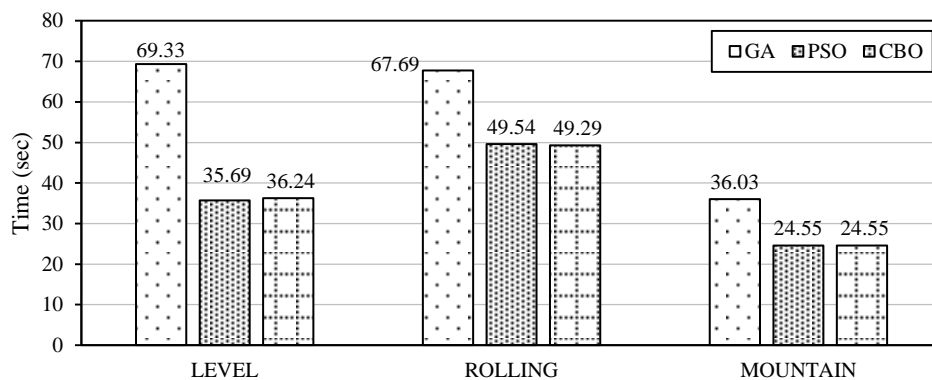

Figure 13. Run time for each iteration in case of GA, PSO and CBO algorithms

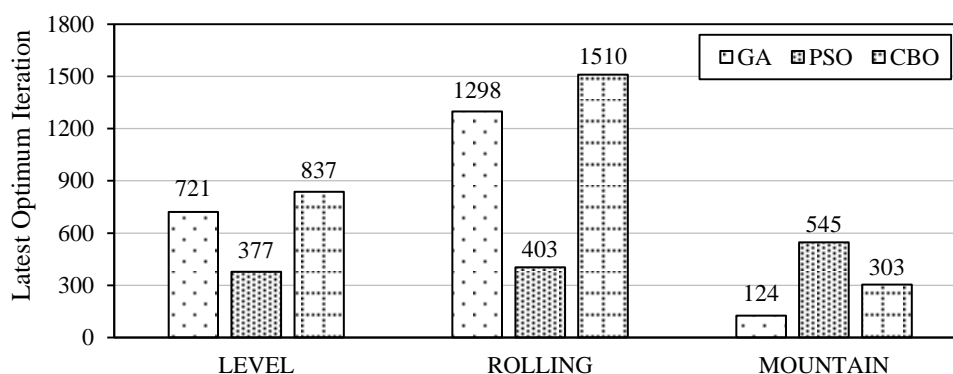

Figure 14. The latest optimum iteration in case of GA, PSO and CBO algorithms

According to Fig. 13, it can be seen that run time for each iteration for the PSO and CBO algorithms is approximately equal and less than GA algorithm. So, it can be expected that by a given number of iterations, the performance of PSO and CBO algorithms will be superior to GA algorithm.

In the level terrain, CBO algorithm finds global optimum solution in 837th iteration, while the GA and PSO algorithms find the local optimum solution in 721th and 377th iteration, respectively. In rolling terrain, CBO algorithm finds optimum solution in 1510th iteration, while the GA and PSO algorithms find the optimum response in 1298th and 403rd iteration, respectively. In mountainous terrain, CBO algorithm finds the optimum solution in 303rd iteration, while the GA and PSO algorithms find the optimum response in 124th and 545th iteration, respectively.

It is evident that the performance of PSO and CBO algorithms in terms of run time for finding optimum solution is superior to GA algorithms.

6. CONCLUSION

In this research, an optimization model was proposed for optimum design of vertical alignment of highways based on minimization of earthwork cost. The proposed optimization model considers practical constraints in design of vertical alignment including maximum and minimum grade of tangents, non-overlapping of vertical curves, minimum elevation of compulsory points, and the minimum length of vertical curves. A MATLAB code was developed for accurate computation of earthwork volumes and implementation of optimization model. The optimization model as well as MATLAB code was assessed by three different examples and three different optimization algorithms including GA, PSO and CBO. Results of this study showed that the developed MATLAB code is able to calculate earthwork volumes with the maximum error of 5.17% in comparison with AutoCAD Land Desktop, which confirms the accuracy of developed code. According to the obtained results for three examples, CBO algorithm has superior performance in terms of finding optimum solution in comparison with GA and PSO. The optimality percentage (difference between initial and optimum earthwork cost in percent) for CBO was obtained as 44.14, 21.42 and 22.54 in level, rolling and mountainous terrain, respectively. These values were obtained as

14.63, 8.98 and 5.76 in case of GA algorithm and 42.72, 13.78 and 21.55 in case of PSO algorithm in level, rolling and mountainous terrain, respectively. The comparison of run times for different optimization algorithms showed that the performance of PSO and CBO is superior to GA algorithms. This study also confirms that the earthwork cost decreases when there is a better balance between cut and fill volumes. Findings of this research show that the modern optimization algorithms, such as CBO algorithm, can improve design of optimum vertical alignment. Such an algorithm has no internal parameter and can be used under different situations.

REFERENCES

- [1] Garber NJ, Hoel LA. *Traffic and Highway Engineering*, Cengage Learning, 2014.
- [2] Abbey L. *Highways*, Van Nostrand Reinhold, New York, 1992.
- [3] AUSTRROADS Guide. *Rural Road Design, Guide to the Geometric Design of Rural Roads*, AUSTRROADS Publication AP-1/89, Sydney, Australia, 1993.
- [4] Papacostas CS, Prevedouros PD. *Transportation Engineering and Planning*, 1993.
- [5] Banks JH. *Introduction to Transportation Engineering*, McGraw-Hill New York, 2002.
- [6] AASHTO. *Policy on Geometric Design of Highways and Streets*, American Association of State Highway and Transportation Officials, Washington, DC, 2011; **1**(990): 158.
- [7] CALTRANS. *Highway Design Manual*, California Department of Transportation Publication, Sacramento, Calif, 200/1-58, 1995.
- [8] Easa SM. Selection of roadway grades that minimize earthwork cost using linear programming, *Transport Res Part A: General* 1988; **22**(2): 121-36.
- [9] Dabbour E, Raahemifar K, Easa S, editors. Optimum vertical curves for highway profiles using nonlinear optimization, *Annual Conference of the Canadian Society for Civil Engineering*, Montréal, Québec, Canada 2002, pp. 1-9.
- [10] Fwa TF, Chan WT, Sim YP. Optimal vertical alignment analysis for highway design, *J Transport Eng* 2002; **128**(5): 395-402.
- [11] Göktepe AB, Lav AH. Method for balancing cut-fill and minimizing the amount of earthwork in the geometric design of highways, *J Transportation Engineering* 2003; **129**(5): 564-71.
- [12] Göktepe AB, Lav AH. Method for optimizing earthwork considering soil properties in the geometric design of highways, *J Survey Eng* 2004; **130**(4): 183-90.
- [13] Soknath M, Piantanakulchai M. Vertical alignment optimization using customized polynomial regression model, *Proceedings of the Eastern Asia Society for Transportation Studies*, 2013.
- [14] Göktepe AB, Lav AH, Altun S, Altıntaş G. Fuzzy decision support system to determine swell/shrink factor affecting earthwork optimization of highways, *Mathemat Computat Applicat* 2008; **13**(1): 61-70.
- [15] Bababeik M, Monajjem MS. Optimizing longitudinal alignment in railway with regard to construction and operating costs, *J Transport Eng* 2012; **138**(11): 1388-95.
- [16] Hare W, Lucet Y, Rahman F. A mixed-integer linear programming model to optimize the vertical alignment considering blocks and side-slopes in road construction, *European J Operat Res* 2015; **241**(3): 631-41.

- [17] Kaveh A, Mahdavi VR. Optimal design of structures with multiple natural frequency constraints using a hybridized BB-BC/Quasi-Newton algorithm, *Period Polytech – Civil Eng* 2013; **57**: 1-12.
- [18] Kaveh A, Dadras A. A guided tabu search for profile optimization of finite element models, *Int J Optim Civil Eng* 2017; **7**(4): 527-37.
- [19] Kaveh A, Hamze-Ziabari SM, Bakhshpoori T. Feasibility of pso-anfis-pso and ga-anfis-ga models in prediction of peak ground acceleration, *Int J Optim Civil Eng* 2018; **8**(1): 1-14.
- [20] Fan WD. Optimal congestion pricing toll design under multiclass transportation network schemes: Genetic algorithm approaches, *Case Studies Transport Policy* 2016; **4**(2): 78-87.
- [21] Papadaki IN, Chassiakos AP. Multi-objective Construction Site Layout Planning Using Genetic Algorithms, *Procedia Eng* 2016; **164**: 20-7.
- [22] Tari FG, Hashemi Z. A priority based genetic algorithm for nonlinear transportation costs problems, *Comput Indust Eng* 2016; **96**: 86-95.
- [23] Khalili-Damghani K, Tavana M, Santos-Arteaga FJ, Ghanbarzad-Dashti M. A customized genetic algorithm for solving multi-period cross-dock truck scheduling problems, *Measure* 2017; **108**: 101-18.
- [24] Sonmez M, Akgüngör AP, Bektaş S. Estimating transportation energy demand in Turkey using the artificial bee colony algorithm, *Energy* 2017; **122**: 301-10.
- [25] Li Y, Ma D, Zhu M, Zeng Z, Wang Y. Identification of significant factors in fatal-injury highway crashes using genetic algorithm and neural network, *Accident Anal Prevent* 2018; **111**: 354-63.
- [26] Holland JH. *Adaptation in Natural and Artificial Systems*, Ann Arbor: University of Michigan Press, 1975.
- [27] Eberhart RC, Kennedy J. A new optimizer using particle swarm theory, *Proceedings of the Sixth International Symposium on Micro Machine and Human Science*, Nagoya, Japan, 1995.
- [28] Dorigo M, Maniezzo V, Coloni A. The ant system: optimization by a colony of cooperating agents, *IEEE Trans Syst Man Cybern B* 1996; **26**: 29-41.
- [29] Kaveh A, Talatahari S. A novel heuristic optimization method: charged system search, *Acta Mech* 2010; **213**: 267-89.
- [30] Yang XS. *Algorithms Nature-Inspired Metaheuristic*, Luniver Press, Beckington, UK, 2008.
- [31] Kaveh A, Farhoudi N. A new optimization method: dolphin echolocation, *Adv Eng Softw* 2013; **59**: 53-70.
- [32] Kaveh A, Mahdavi VR. Colliding bodies optimization: a novel meta-heuristic method, *Comput Struct* 2014; **139**: 18-27.
- [33] Kaveh A, Ilchi Ghazaan M. Computer codes for colliding bodies optimization and its enhanced version, *Int J Optim Civil Eng* 2014; **4**(3): 321-32.
- [34] Regulations of geometric design of roads (RGDE), Publication No. 415, *President Deputy Strategic Planning and Control*, 2011.