

STRUCTURAL DAMAGE DETECTION IN PLANE STRESS PROBLEMS BY USING TIME DOMAIN RESPONSES AND TOPOLOGY OPTIMIZATION

F. Damghani and S.M. Tavakkoli^{*,†}

Civil Engineering Department, Shahrood University of Technology, Shahrood, Iran

ABSTRACT

An efficient method is proposed by using time domain responses and topology optimization to identify the location and severity of damages in two-dimensional structures under plane stress assumption. Damage is assumed in the form of material density reduction in the finite element model of the structure. The time domain responses utilized here, are the nodal accelerations measured at certain points of the structure. The responses are obtained by the Newmark method and contaminated with uniformly random noise in order to simulate real conditions. Damage indicators are extracted from the time domain responses by using Singular Value Decomposition (SVD). The problem of damage detection is presented as a topology optimization problem and the Solid Isotropic Material with Penalization (SIMP) method is used for appropriate damage modeling. The objective function is formed based on the difference of singular values of the Hankel matrix for responses of real structure and the analytical model. In order to evaluate the correctness of the proposed method, some numerical examples are examined. The results indicate efficiency of the proposed method in structural damage detection and its parameters such as resampling length in SVD, penalty factor in the SIMP method and number and location of sensors are effective parameters for improving the results.

Keywords: structural damage detection; structural health monitoring; time domain responses; SIMP; topology optimization.

Received: 20 November 2022; Accepted 15 January 2023

1. INTRODUCTION

Structural health monitoring aims to extract characteristics of structures by using structural

^{*}Corresponding author: Civil Engineering Department, Shahrood University of Technology, Shahrood, Iran

[†] E-mail address: mtavakkoli@shahroodut.ac.ir (S.M. Tavakkoli)

responses via performing inverse analysis and detect damages by tracking changes occurred in the characteristics. The occurrence of damage causes change in physical characteristics of a structure such as stiffness, mass and damping, which affects the vibration responses. Therefore, in recent decades, non-destructive methods of damage identification using vibration responses have been considered by several researchers.

In recent years, topology optimization is being utilized as a robust tool for damage identification. In such problems, the material density reduction in each element is assumed as damage, therefore the material density instead of the damage severity is considered as design variables. Lee et al. [1] identified damages in plate and beam structures by using both resonant and anti-resonant frequencies as an objective function and the moving asymptotes method. Niemann et al. [2-4] estimated the approximate location of the damage in CFRP laminates after impact tests. This approach was based on the correlation of the local stiffness loss and the change in modal parameters due to damages in structures. Nishizu et al. [5] identified shape and location of damage in plane stress and plate bending structures by analyzing eigenfrequencies and using the moving asymptotes method. Although, identifying the damage shape was not accurate, determining the damage location was acceptable. Zhang et al. [6] identified damage in continuum structures by using data of natural circular frequencies and the level set method. Eslami et al. [7] defined two objective functions based on natural frequencies and mode shapes and used the SIMP method to detect structural damages in plane stress problems. Abdollahi and Tavakkoli [8] used mode expansion techniques and the SIMP method to identify damages in three dimensional elasticity problems.

A local damage identification method based on topology optimization and the SIMP method is also proposed by Ryuzono et al. [9]. The authors analyzed visualized ultrasonic wave propagation on a stainless-steel plate with an artificial crack, then defined an objective function based on the maximum amplitude of the mean stress which adopted as the ultrasonic feature. Sugai et al. [10] presented a damage identification method based on topology optimization and Lasso regularization. Static displacements or dynamic responses were used to identify the structural damages. Due to the large number of design variables, a regularization was added to the objective functions to suppress active design variables and delete artificially generated damages during topology optimization process. Dizaji et al. [11] detected and reconstructed the location, extent and 3D shape of internal damage in structural members. Full-field response data obtained by digital image correlation were leveraged in a topology optimization framework. The method of moving asymptotes as the optimization algorithm was used to minimize the objective function.

According to the previous studies, it can be observed that modal parameters are often used to extract the damage indicators for the objective functions. The objective function proposed in this research, is based on singular values which extracted from the time domain acceleration responses and for the first time is used in a topology optimization problem to detect the location and severity of damage. The SIMP method is employed that makes the possibility of providing porous areas of materials which enables the algorithm to find both the location and extent of the damage throughout the design domain. A simple algorithm of steepest descent method is used to optimize the objective function. It is noted that meta-heuristic algorithms have mainly be used for damage detection for minimizing the objective functions based on modal data and modal strain energy [12-17] and also based on time

domain responses [18-21].

In field of damage detection, SVD is usually used for different purposes such as feature extraction, noise reduction and eliminating environmental and operational effects. Vanlanduit et al. [22] proposed a technique based on robust SVD to detect damage in structures from measurements taken under different conditions. The robust SVD was able to compute the distance of an observation to the subspace spanned by the intact measurements. Liu et al. [23-25] developed an ultrasonic damage detection method based on SVD. They used the orthogonality property of singular vectors and through that separated environmental and operational variations into different singular vectors. Rahai et al. [26] proposed a sensitivity-based model updating method using SVD of transfer function subsets. The first-order and second-order changes of SVD parameters was presented to detect damage severity and location.

The objective of this study is utilizing the SVD to extract damage sensitive features under random excitation with additional noises. It is assumed that the structure is made of homogeneous and isotropic materials and it is within the range of small deformations with linear behavior. In this article, first, in section 2, the process of calculating the time domain responses is described. In section 3, the SVD method for calculating singular values and forming the objective function are presented. Section 4 is assigned to defining the optimization problem and introducing the algorithm parameters. The optimization algorithm and numerical examples are provided in sections 5 and 6.

2. CALCULATION OF TIME DOMAIN RESPONSES

When a damage is occurred in a structure, the vibration characteristics are affected. One of the most important characteristics is the time domain responses, which can be measured directly and at a lower cost than other data. According to the principles of structural dynamics, the governing differential equation for multi degree of freedom (DOF) structures is shown as below [27]:

$$\mathbf{M}\ddot{\mathbf{X}} + \mathbf{C}\dot{\mathbf{X}} + \mathbf{K}\mathbf{X} = \mathbf{F}(t) \quad (1)$$

where \mathbf{M} , \mathbf{C} and \mathbf{K} denote the mass, damping and stiffness matrices of the structure, respectively. $\ddot{\mathbf{X}}$, $\dot{\mathbf{X}}$ and \mathbf{X} represent vectors of response acceleration, velocity and nodal displacement in the global coordinate system, respectively, and $\mathbf{F}(t)$ is the time-dependent vector of the external load applied to the structure.

This study is based on the output-only identification method and damage identification is performed only by using the measured responses of the structure. In all output-only identification methods, a special type of excitation called white noise is considered as the input of the system. Because ambient excitations cover a wide range of frequencies and can be well simulated by the broad band excitation of white noise which has the constant intensity in all frequencies [28].

The second-order ordinary differential equations in the time domain given by equation (1) can be solved by the Newmark method [29] that is used here to evaluate the vibration

responses of the structure. According to the Newmark method, nodal displacements in the $n+1^{\text{th}}$ step can be determined as follows:

$$X_{n+1} = \mathbf{K}_{eq}^{-1} \times \mathbf{F}_{eq} \quad (2)$$

where \mathbf{K}_{eq} and \mathbf{F}_{eq} are the equivalent stiffness matrix and equivalent nodal forces calculated by equation (3) and (4), respectively, given as below:

$$\mathbf{K}_{eq} = a_0 \mathbf{M} + a_1 \mathbf{C} + \mathbf{K} \quad (3)$$

$$\mathbf{F}_{eq} = \mathbf{F} + \mathbf{M}(a_0 X_n - a_2 \dot{X}_n - a_3 \ddot{X}_n) + \mathbf{C}(a_1 X_n - a_4 \dot{X}_n - a_5 \ddot{X}_n). \quad (4)$$

Finally, to determine the vector of nodal acceleration and velocity, the equations (5) and (6) can be used as:

$$\ddot{X}_{n+1} = a_0 (X_{n+1} - X_n) - a_2 \dot{X}_n - a_3 \ddot{X}_n \quad (5)$$

$$\dot{X}_{n+1} = \dot{X}_n - a_6 \ddot{X}_n - a_7 \ddot{X}_{n+1} \quad (6)$$

where the factors a_i ($i = 0, \dots, 7$) are given as:

$$\begin{aligned} a_0 &= \frac{1}{\alpha \Delta t^2}, & a_1 &= \frac{\beta}{\alpha \Delta t}, & a_2 &= \frac{1}{\alpha \Delta t}, & a_3 &= \frac{1}{2\alpha} - 1, & a_4 &= \frac{\beta}{\alpha} - 1, \\ a_5 &= \frac{\Delta t}{2} \left(\frac{\beta}{\alpha} - 2 \right), & a_6 &= \Delta t (1 - \alpha) & \text{and} & a_7 &= \beta \Delta t \end{aligned} \quad (7)$$

where $\alpha = \frac{1}{4}(1 + \gamma)^2$, $\beta = \frac{1}{2} + \gamma$ and γ is considered to be zero in this study.

3. SINGULAR VALUES AS DAMAGE INDICATORS

The basic principle in vibration-based damage detection methods is that the damage affects the properties of mass, stiffness and damping of the structure. The problem of damage detection can formulate in the form of minimizing a correlation indicator between the structural data in healthy and damaged states. In this paper, these indicators are singular

values obtained from the time domain responses via SVD method as described below, and finally, topology optimization is used to identify the location and severity of the damage. SVD is a method of signal processing that has become one of the most useful tools in mathematics and related fields. The measured acceleration responses with length N are selected as a series of data for analysis. The steps of SVD for signal processing are as follows.

3.1 Matrixing of vibration signal

In the first step, it is necessary that the vibration signal to be transformed into a matrix structure. In order to form decomposed signal components to inherit more information from the raw signal, the Hankel matrix structure is used. In order to construct the matrix, the phase space needs to be reconstructed by the coordinate delay method so that the elements in each anti-diagonal are equal [30]. The Hankel matrix is obtained as:

$$\mathbf{H} = \begin{bmatrix} x(1) & x(2) & \cdots & x(N-L+1) \\ x(2) & x(3) & \cdots & x(N-L+2) \\ \vdots & \vdots & \ddots & \vdots \\ x(L) & x(L+1) & \cdots & x(N) \end{bmatrix} \quad (8)$$

where the number of $x(1)$ to $x(L)$ denotes the resampling length of the signal which can be a value between 1 and N .

3.2 SVD of a matrix

Based on the matrix decomposition theory, the SVD of \mathbf{H} can be expressed as:

$$\mathbf{H} = \mathbf{U}\mathbf{\Sigma}\mathbf{V}^T \quad (9)$$

where $\mathbf{\Sigma} = \text{diag}(\sigma_1, \sigma_2, \sigma_3, \dots, \sigma_r)$ denotes the diagonal matrix of the singular values σ_i ($i = 1, 2, 3, \dots, r$) of \mathbf{H} , and $\sigma_1 \geq \sigma_2 \geq \sigma_3 \geq \dots \geq \sigma_r$. The \mathbf{U} and \mathbf{V} are a pair of orthogonal matrices which their columns represent the left and right-singular vectors of \mathbf{H} , respectively, and are shown as below:

$$\begin{cases} \mathbf{U} = [u_1, u_2, u_3, \dots, u_r] \in \mathbf{R}^{L \times r} \\ \mathbf{V} = [v_1, v_2, v_3, \dots, v_r] \in \mathbf{R}^{r \times N-L+1} \end{cases} \quad (10)$$

where the column vectors v_i and u_i are the base vectors in row space and column space of matrix \mathbf{H} , respectively.

3.3 Objective function

Selection of objective function in damage detection problems is a critical issue as it plays essential role in convergence of the optimization algorithm. In many researches, various correlation indices have been chosen as the objective function. Since one of the common challenges in time domain responses-based damage detection methods is the large number of data; using SVD is an effective method to reduce the variables in the objective function. SVD can approximate a matrix with high accuracy by reducing the data to a certain number of singular values. This feature can be used to compress data with shortened forms of singular values instead of time history acceleration data.

In this research, the objective function is based on the difference of singular values obtained by SVD from the measured responses of the real structure and the model as follows:

$$\min \rho : \left\{ f(\rho) = \sum_{i=1}^N \sum_{j=1}^L \left(\frac{\sigma_{ij}(\rho) - \sigma_{ij}^*}{\sigma_{ij}^*} \right)^2 \right\} \quad (11)$$

subjected to : $0 \leq \rho_k \leq 1 \quad , \quad k = 1, \dots, n_e$

where ρ is the design variables vector that is considered the density of each element here. N and L are the number of sensors and resampling length, respectively. $\sigma_{ij}(\rho)$ and σ_{ij}^* are the singular values which extracted from the acceleration responses of the analytical and real models of the structure, respectively. ρ_k is the damage index of the element k and n_e is the number of elements.

4. DAMAGE DETECTION BY USING TOPOLOGY OPTIMIZATION

In this research, topology optimization is used as a tool to detect the damaged domain at the element level. For this purpose, the damage is assumed in the form of a stiffness reduction which is caused by the material density reduction. In the field of damage detection, the objective function is the difference between the observed load effects in the physically damaged sample and its simulated intact counterpart. Here, the SIMP method [31] is used to parametrize the problem. In this method by the power law, materials with medium density are penalized in order to encourage to a favorable configuration and remove materials. The damage parameter which is the density ρ_e , is defined over each element. In this way, the damage identification problem is converted to a material density distribution problem in the design domain D as follows:

$$\rho_e = \begin{cases} 1 & \mathbf{x} \in D \setminus \Omega_d & \text{no damage} \\ 0 < \rho_{\min} \leq \rho_e < 1 & \mathbf{x} \in \Omega_d & \text{damage} \end{cases} \quad (12)$$

where Ω_d and $D \setminus \Omega_d$ are the damaged and intact domains, respectively. The Young's modulus of the element e is expressed as a function of damage parameter as follows [32]:

$$E_e(\rho_e) = (E_1 - E_0)\rho_e^\mu + E_0 \quad (13)$$

where E_1 and E_0 are Young's modulus of solid (i.e., perfectly intact) and void elements (i.e., perfectly damaged), respectively. Also, μ is the penalization exponent. To avoid singularity, a small stiffness ($E_0 = 0.001$ MPa) is assigned for fully damaged elements. Also, in order to achieve better results, the values of μ by using the continuation method changes in the first steps during the optimization process [33].

According to the SIMP method, due to any density reduction in element e , the elasticity matrix $\underline{\mathbf{C}}_e$ and consequently element matrices are affected as:

$$\underline{\mathbf{C}}_e(\rho_e) = \rho_e^\mu \underline{\mathbf{C}}_e \quad , \quad \mu \geq 1 \quad (14)$$

$$\mathbf{K}_e(\rho_e) = \rho_e^\mu \int_{\Omega} \mathbf{B}^T \underline{\mathbf{C}}_e \mathbf{B} d\Omega \quad (15)$$

$$\mathbf{M}_e(\rho_e) = \rho_e^\mu \mathbf{M}_e^* = \int_{\Omega} \rho_e^\mu \mathbf{N}^T d \mathbf{N} d\Omega \quad (16)$$

where \mathbf{K}_e and \mathbf{M}_e are the element stiffness and mass matrices, respectively. \mathbf{B} is the strain-displacement matrix and Ω is the element volume, \mathbf{M}_e^* is the element mass matrix of undamaged structure, d is the material density and \mathbf{N} is the finite element shape functions matrix. Also changes in the stiffness and mass matrix lead to changes in the damping matrix. In this research, classical Rayleigh damping [27] is used to construct the damping matrix as follows:

$$\mathbf{C} = a_1 \mathbf{M} + a_2 \mathbf{K} \quad (17)$$

$$a_1 = \zeta \frac{2\omega_i \omega_j}{\omega_i + \omega_j} \quad , \quad a_2 = \zeta \frac{2}{\omega_i + \omega_j} \quad (18)$$

where \mathbf{C} is the damping matrix, a_1 and a_2 are constants of proportionality and ζ is the damping ratio. Therefore, the following equation is applied to the damping matrix:

$$\mathbf{C}_e(\rho_e) = \rho_e^\mu \mathbf{C}_e^* \quad (19)$$

where \mathbf{C}_e^* is the element damping matrix of undamaged structure. Therefore, according to the above equations and equation (1), it is concluded that the acceleration, velocity and displacement vectors are affected by damage.

In the present problem, since the gradient-based optimization method is used, sensitivity analysis needs to be performed by differentiating the objective function with respect to the design variables. In topology optimization under dynamic loads with numerous design variables, the analytical sensitivity analysis method is not recommended because for each design variable, needs to solve the second-order differential equation that is a time-consuming process and makes this method inefficient [34]. Therefore, in the present problem, the finite difference method is used for sensitivity analysis.

5. OPTIMIZATION ALGORITHM

In this paper, the steepest descent method is used to solve the unconstrained optimization problem. Therefore, d^k which is the search direction in iteration k is considered as below:

$$d^k = -\nabla f(\rho^k) \quad (20)$$

During successive iterations, design variables are updated using the following equation

$$\rho^{k+1} = \rho^k - \alpha \nabla f(\rho^k) \quad (21)$$

where α is a positive numerical parameter and is called the step size, which is determined here by the golden search method. The steepest descent algorithm for the proposed damage detection problem is given in Table 1 [35], [36].

Table 1. The steepest descent algorithm for damage detection

Step 1. Given $\rho^{(k)}$ (starting value of design variable), Setting $k = 0$ (Repeat counter), Selecting $\varepsilon > 0$ (Convergence parameter).
Step 2. Calculating $f(\rho^{(k)})$ and $\nabla f(\rho^{(k)})$ (function and gradient vector).
Step 3. Calculating $d^k = -\nabla f(\rho^{(k)})$ (search direction).
Step 4. If $\ \nabla f(\rho^{(k)})\ < \varepsilon$ then the iteration process stops because $\rho^* = \rho^{(k)}$ is the optimum point.
Step 5. Calculating the step size α_k (by using the golden search method) based on

minimization $f(\alpha) = f(\rho^{(k)} + \alpha d^{(k)})$ in direction $d^{(k)}$.

Step 6. Updating design variables using $\rho^{(k+1)} = \rho^{(k)} + \alpha_k d^{(k)}$.
 $k = k + 1$ and going to step 2.

It is also noted that in the first step it is assumed that the structure is perfectly healthy and, therefore, starting value of design variables is considered to be 1 (i.e., $\rho^0 = 1$). In the second step, the mass, stiffness and damping matrices and the time domain responses of the structure are calculated in order to determine the objective function. Also, the gradient vector of the objective function is obtained by sensitivity analysis. In the third step, it is necessary to apply the design variables constraint in the form of $0 < \rho_e \leq 1$.

6. NUMERICAL EXAMPLES

In order to demonstrate the capability of the introduced objective function, four numerical examples are presented in this section. In all examples, Young's modulus and Poisson's ratio are considered as 2 Pa and 0.3, respectively, and the material density is 0.00785 kg/cm^3 . In order to simulate ambient excitations, the vibration load is applied in the form of Gaussian white noise at one of DOFs in the vertical direction. The random acceleration response is calculated using the finite element analysis and the Newmark's time step method for all DOFs, with a sampling rate of 1000 samples per second and a duration of 0.2 Sec. The initial value of the design variables is assumed to be 1, that means no damage is considered in structural elements at the beginning of the optimization process. Also, the penalty factor (μ) by using the continuation method in the first 100 optimization steps is gradually decreased from 3 to 1, and the optimization continues with $\mu = 1$ in the next steps. One of the main issues related to structural damage detection in real situations, is sensitivity to noise. It was decided to add white Gaussian noise to the acceleration time history responses generated by the finite element code. To achieve this, a scaler quantity SNR (Signal-to-Noise-Ratio) is specified to define the 'amplitude' of the noise with respect to that of the clean signal. When the noise level is given by a particular value of SNR, it means that a noisy signal with such an SNR has been added to the time domain responses of each node. Therefore, severe experimental conditions are simulated, because the noisy sequences affecting different nodes are uncorrelated [37]. In all the examples, the signal is affected by noise level characterized by the value SNR=40.

6.1 Example 1

A cantilever beam with dimensions of 40×10 cm and thickness of 1 cm is shown in Figure 1. To solve the problem, the beam is discretized into 100 square linear finite elements with dimensions of 2×2 cm. Damage is assumed as 100% density reduction in two elements. Five sensors are installed in the specified nodes on the structure to record the acceleration responses in vertical DOFs. The damaged elements, the location of sensors and dynamic load are depicted in Figure 1. The vibration load applied to the end of the beam is a white noise random excitation that is shown in Figure 2.

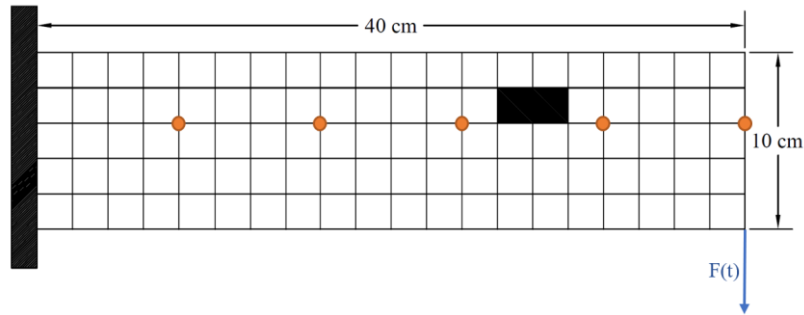

Figure 1. The cantilever beam related to Example 1

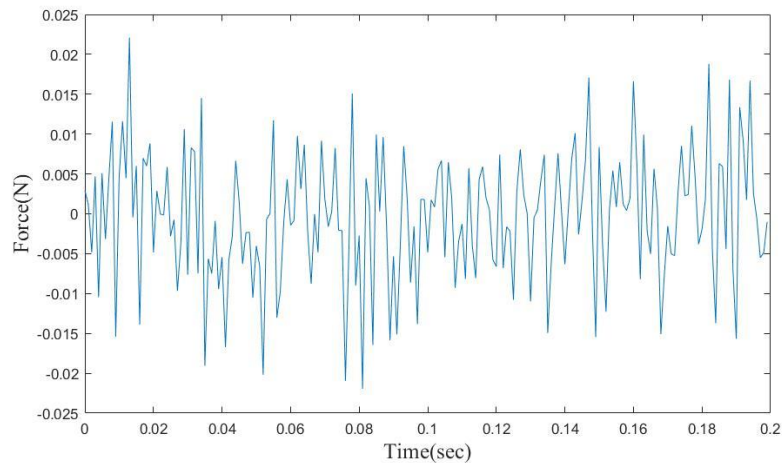
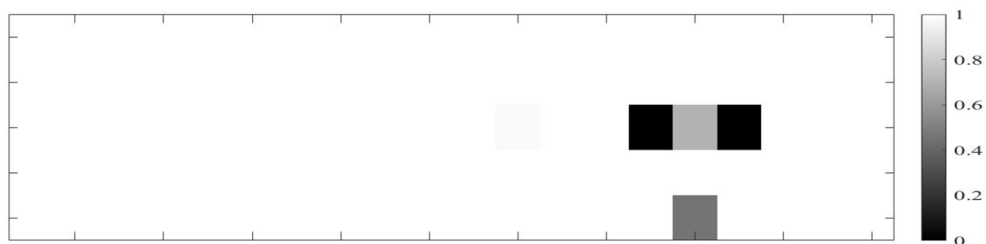

Figure 2. Applied random white noise excitation

Choosing appropriate signal resampling length is of particular importance. In order to investigate its effect on the accuracy of damage detection, the problem is solved with two different resampling lengths. These values are considered as 10 and 50. The detected damages after 400 iterations along with the iteration history graphs are shown in Figures 3 and 4. It is observed that in two cases, the damage location and severity are identified and there are some fictitious damages in a few elements. In the second state with resampling length as 50, there are some spikes in iteration history of the objective function in the last iterations. In fact, using too long resampling length causes signal characteristics are not appropriately derived. Therefore, with resampling length of 10, more acceptable results have been obtained and the severity of fictitious damages has been reduced.



(a)

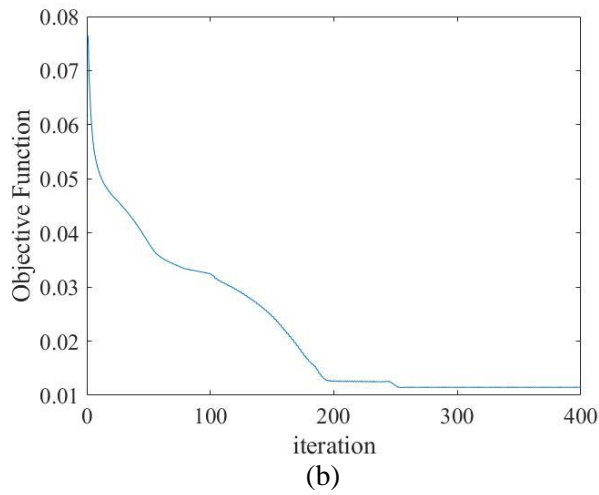

Figure 3. Results with resampling length of 10: (a) identified damages (b) iteration history

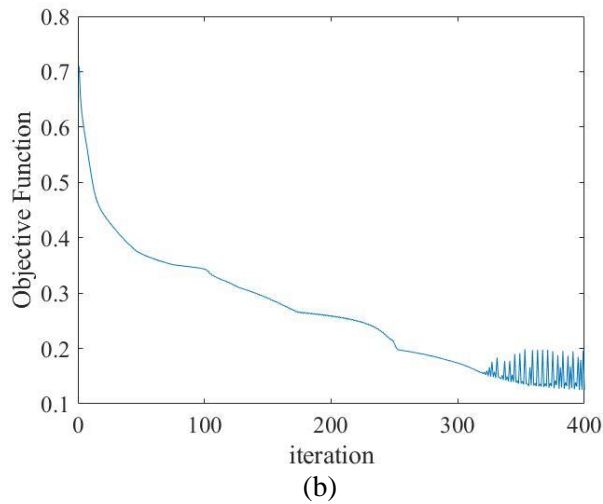
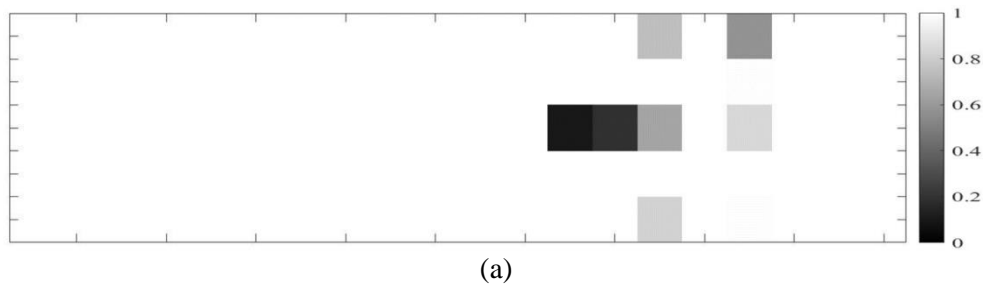

Figure 4. Results with resampling length of 50: (a) identified damages after 400 iterations (b) iteration history

6.2 Example 2

A simple supported beam is studied in this example where the damages are assumed in two

elements with 100% decrease in density, as depicted in Figure 5. The vibration load applies to the middle node of the beam as a random excitation and five sensors are used in a row that records acceleration responses in vertical DOFs. The resampling length is chosen equal to 10.

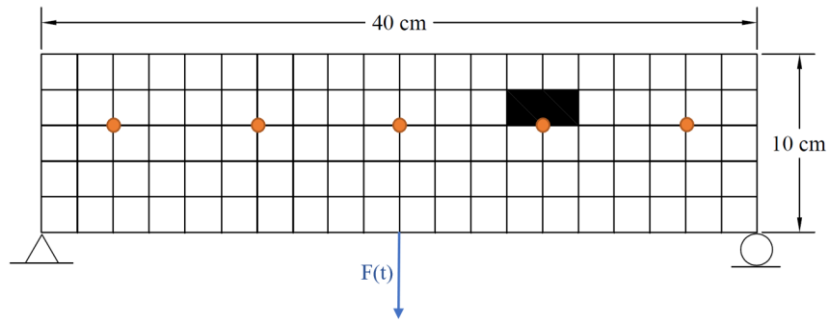
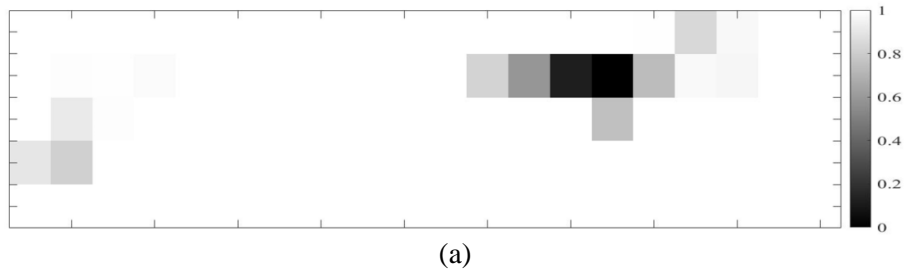
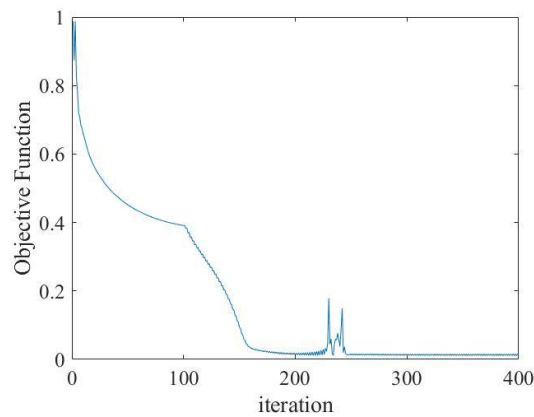

Figure 5. The simple supported beam in Example 2

Figure 6 shows damage detection results and the iteration history. The results indicate that the location and severity of damage are properly identified. In addition, fictitious damages are also appeared in the adjacent elements to the damaged area and left support.



(a)



(b)

Figure 6. Results of Example 2: (a) identified damages (b) iteration history

6.3 Example 3

In this example, an L-shaped beam is considered as depicted in Figure 7 with two damaged

elements and three sensors. The density of damaged elements is reduced by 100%. The beam is divided into 60 square elements with dimensions of 2×2 cm. The sensors record the acceleration responses in vertical DOFs. The resampling length of SVD is considered as 10.

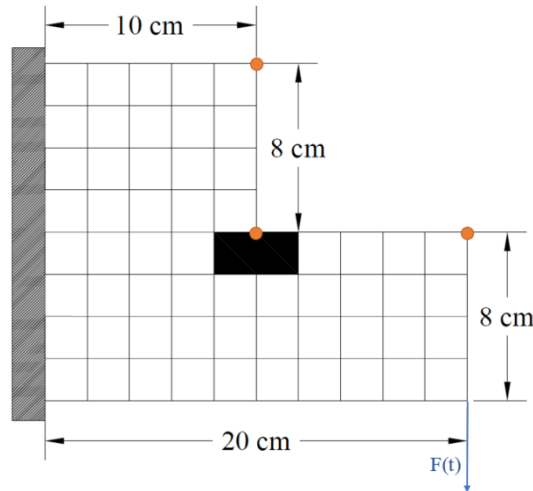

Figure 7. The L-shaped beam in Example 3 - sensors arrangement 1

In order to investigate the effect of location of the sensors on results accuracy, the problem is solved in two states with two different sensors arrangements. The arrangements are shown in Figures 7 and 8. The damage detection results and iteration history graphs are shown in Figures 9 and 10. From the results, it is clear that damages are identified more accurate for the first arrangement and also less fictitious damages are appeared in the structure. It can be concluded that it is more appropriate to install the sensors at the points that have larger displacement and acceleration.

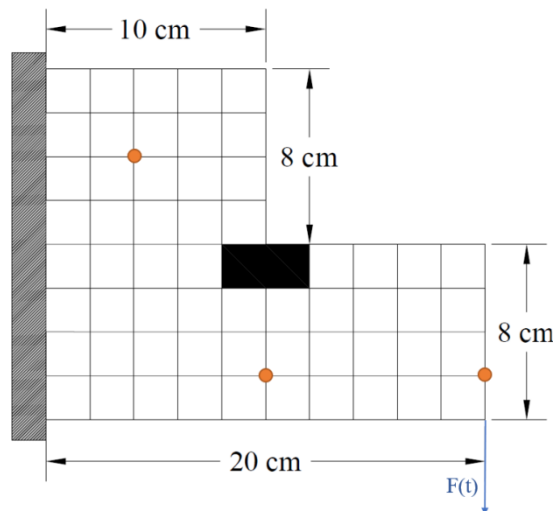

Figure 8. The L-shaped beam in Example 3 - sensors arrangement 2

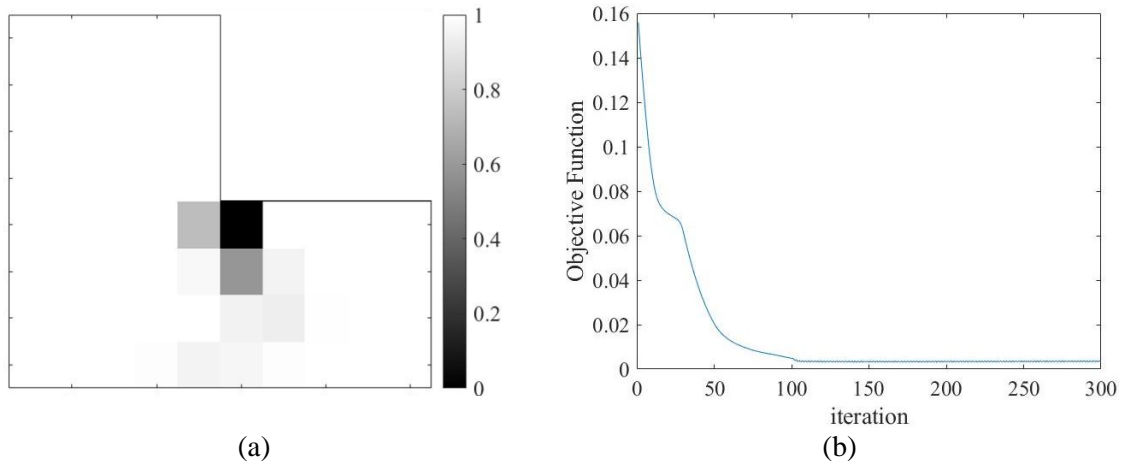

Figure 9. Results for sensor arrangements 1: (a) identified damages (b) iteration history

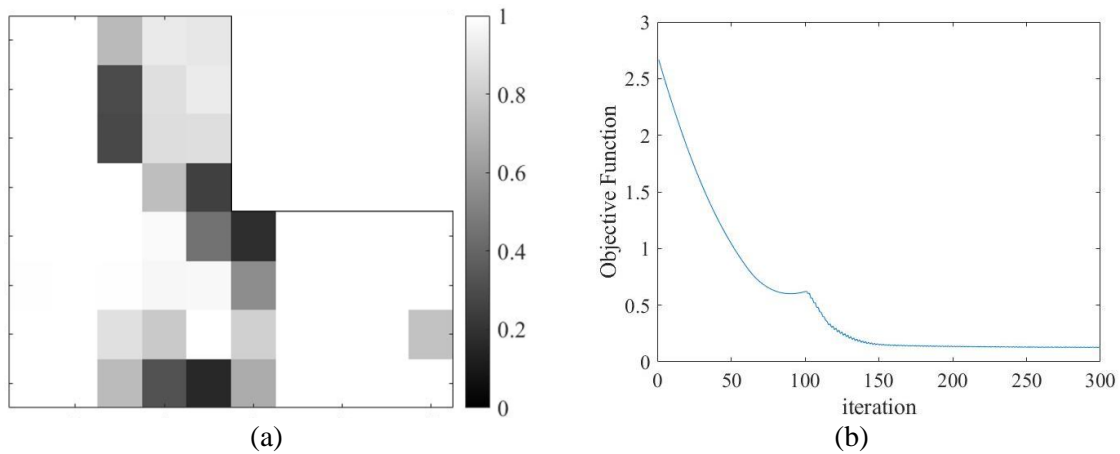

Figure 10. Results for sensor arrangements 2: (a) identified damages (b) iteration history

6.4 Example 4

In this example a cantilever beam is considered with dimensions of 20×18 cm with an opening with dimensions of 6×8 cm as illustrated in Figure 11. The beam is discretized into 68 square linear finite elements with dimensions of 2×2 cm. Damage exists in one element. Three sensors have been installed in the specified nodes on the structure to record the vertical acceleration responses. The resampling length of SVD is set to be 10.

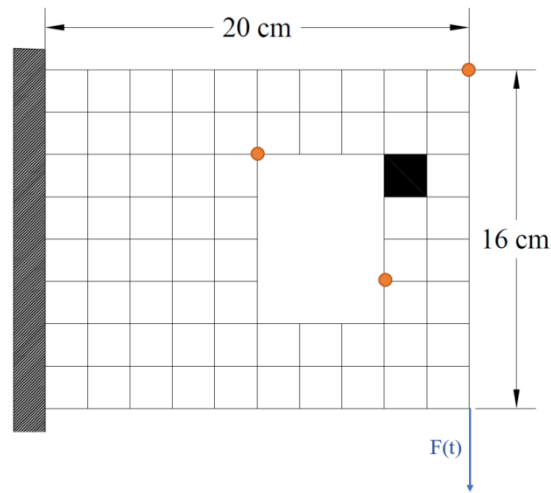

Figure 11. The cantilever beam in Example 4

According to Figure 12, the results show that the damage severity and location is identified correctly, however, some fictitious damages are slightly appeared. It should also be noted that the slope discontinuity in iteration history is because the continuation method is used in the first 100 iterations where the penalty exponent μ is reduced from 3 to 1 and after that remains constant.

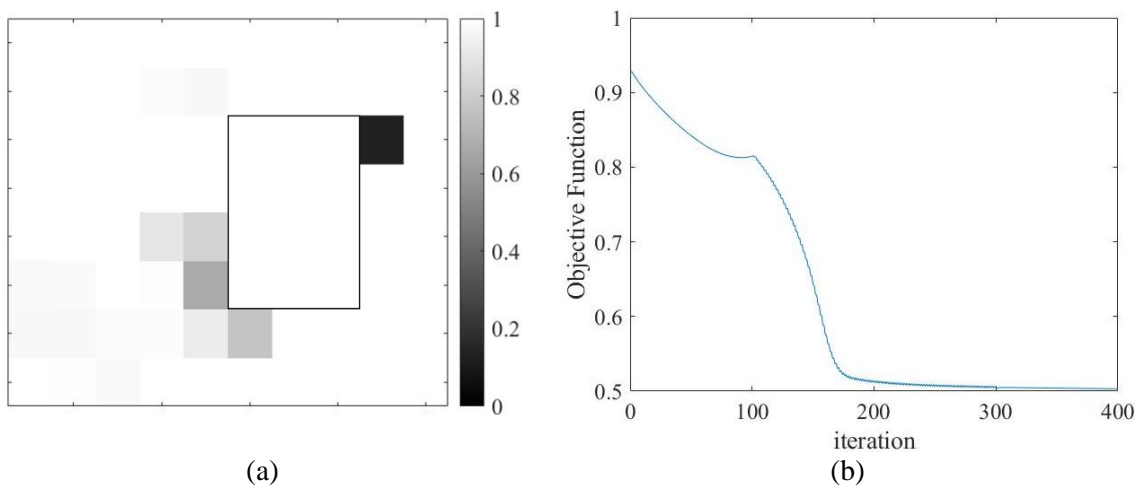

Figure 12. Results of Example 4: (a) identified damages (b) iteration history

7. CONCLUSION

This paper presents a vibration-based damage detection method by using topology optimization in which singular values extracted from acceleration responses are considered as the objective function. The damage detection problem is formulated as a standard optimization problem to minimize the objective function, and find continuous damage variables. The objective function is defined based on singular values of the Hankel matrix

that is constructed by time domain acceleration responses measured from a given number of sensors installed on the structure. The damage is modeled as a density reduction in the structure and the SIMP method is used to parameterize the topology. The sensitivity analysis is achieved by the finite difference method and the damage detection problem is solved by the steepest descent method. Numerical examples show that the proposed method can evaluate the location of damages by using time domain responses of the structure under random excitation with additional noise. The examples also show that the results can be improved by selecting appropriate algorithm parameters such as resampling length to form the Hankel matrix, penalty exponent values in the continuation method, and the number and location of sensors on the structure.

REFERENCES

1. Lee JS, Kim JE, Kim YY. Damage detection by the topology design formulation using modal parameters. *Int J Numer Methods Eng* 2007; **69**(7): 1480–98.
2. Niemann H, Morlier J, Shahdin A, Gourinat Y. Damage localization using experimental modal parameters and topology optimization. *Mech Syst Signal Process* 2010; **24**(3): 636–52.
3. Shahdin A, Morlier J, Niemann H, Gourinat Y. Correlating low energy impact damage with changes in modal parameters: diagnosis tools and FE validation. *Struct Heal Monit* 2011; **10**(2): 199–217.
4. Morlier J, Niemann H, Shahdin A. Topology optimization for robust damage localization using aggregated FRFs statistical criteria. In: Applied Mechanics and Materials. *Trans Tech Publ* 2014; p. 513–8.
5. Nishizu T, Takezawa A, Kitamura M. Eigenfrequency-based damage identification method for non-destructive testing based on topology optimization. *Eng Optim* 2017; **49**(3): 417–33.
6. Zhang W, Du Z, Sun G, Guo X. A level set approach for damage identification of continuum structures based on dynamic responses. *J Sound Vib* 2017; **386**: 100–15.
7. Eslami SM, Abdollahi F, Shahmiri J, Tavakkoli SM. Structural Damage Detection By Using Topology Optimization for Plane Stress Problems. *Int J Optim Civ Eng [Internet]* 2019; **9**(1): 159–76. Available from: <http://ijoce.iust.ac.ir/article-1-380-fa.html>
8. Abdollahi F, Tavakkoli SM. Damage Identification By Using Modal Expansion and Topology Optimization in Three Dimensional Elasticity Problems. *Iust [Internet]* 2019; **9**(4): 543–60. Available from: <http://ijoce.iust.ac.ir/article-1-408-en.html>
9. Ryuzono K, Yashiro S, Nagai H, Toyama N. Topology optimization-based damage identification using visualized ultrasonic wave propagation. *Materials (Basel)* 2020; **13**(1): 6–13.
10. Sugai R, Saito A, Saomoto H. Damage Identification Using Static and Dynamic Responses Based on Topology Optimization and Lasso Regularization. In: *ASME 2020 International Design Engineering Technical Conferences and Computers and Information in Engineering Conference [Internet]* 2020. Available from: <https://doi.org/10.1115/DETC2020-22279>
11. Dizaji MS, Alipour M, Harris DK. Subsurface damage detection and structural health

- monitoring using digital image correlation and topology optimization. *Eng Struct* 2021; **230**: 111712.
12. Kaveh A, Javadi SM, Maniat M. Damage assessment via modal data with a mixed particle swarm strategy, ray optimizer, and harmony search. 2014;
 13. Kaveh A, Zolghadr A. An improved CSS for damage detection of truss structures using changes in natural frequencies and mode shapes. *Adv Eng Softw* 2015; **80**: 93–100.
 14. Kaveh A, Maniat M. Damage detection based on MCSS and PSO using modal data. *Smart Struct Syst* 2015; **15**(5): 1253–70.
 15. Kaveh A, Zolghadr A. Cyclical parthenogenesis algorithm for guided modal strain energy based structural damage detection. *Appl Soft Comput* 2017; **57**: 250–64.
 16. Kaveh A, Dadras A. Structural damage identification using an enhanced thermal exchange optimization algorithm. *Eng Optim* 2018; **50**(3): 430–51.
 17. Kaveh A, Rahmani P, Dadras Eslamlou A. A multistage damage detection approach using graph theory and water strider algorithm. *Iran J Sci Technol Trans Civ Eng* 2021; 1–22.
 18. Fallahian S, Joghataie A, Kazemi MT. Structural damage detection using time domain responses and Teaching-Learning-Based Optimization (TLBO) algorithm. *Sci Iran* 2018; **25**(6): 3088–100.
 19. Seyedpoor SM, Ahmadi A, Pahnabi N. Structural damage detection using time domain responses and an optimization method. *Inverse Probl Sci Eng [Internet]* 2019; **27**(5): 669–88. Available from: <https://doi.org/10.1080/17415977.2018.1505884>
 20. Pahnabi N, Seyedpoor SM. Damage identification in connections of moment frames using time domain responses and an optimization method. *Front Struct Civ Eng* 2021; **15**(4): 851–66.
 21. Nabavi S, Gholampour S, Haji MS. Damage detection in frame elements using Grasshopper Optimization Algorithm (GOA) and time-domain responses of the structure. *Evol Syst* 2022; **13**(2): 307–18.
 22. Vanlanduit S, Parloo E, Cauberghe B, Guillaume P, Verboven P. A robust singular value decomposition for damage detection under changing operating conditions and structural uncertainties. *J Sound Vib* 2005; **284**(3–5): 1033–50.
 23. Liu C, Harley J, O'Donoghue N, Ying Y, Altschul MH, Bergés M, et al. Robust change detection in highly dynamic guided wave signals with singular value decomposition. In: *2012 IEEE International Ultrasonics Symposium. IEEE*; 2012. p. 483–6.
 24. Liu C, Harley JB, Ying Y, Oppenheim IJ, Bergés M, Greve DW, et al. Singular value decomposition for novelty detection in ultrasonic pipe monitoring. In: *Sensors and Smart Structures Technologies for Civil, Mechanical, and Aerospace Systems* 2013. SPIE; 2013. p. 498–508.
 25. Liu C, Harley JB, Bergés M, Greve DW, Oppenheim IJ. Robust ultrasonic damage detection under complex environmental conditions using singular value decomposition. *Ultrasonics* 2015; **58**: 75–86.
 26. Rahai M, Esfandiari A, Bakhshi A. Detection of structural damages by model updating based on singular value decomposition of transfer function subsets. *Struct Control Heal Monit* 2020; **27**(11): e2622.
 27. Chopra AK. Dynamics of structures. Pearson Education India; 2007.

28. Brincker R, Ventura C. Introduction to operational modal analysis. John Wiley & Sons; 2015.
29. Bathe K-J. Finite element procedures. Klaus-Jurgen Bathe; 2006.
30. Shen Z, Shi Z, Shen G, Zhen D, Gu F, Ball A. Informative singular value decomposition and its application in fault detection of planetary gearbox. *Meas Sci Technol* 2022; **33**(8): 85010.
31. Bendsøe MP. Optimal shape design as a material distribution problem. *Struct Optim* 1989; **1**(4): 193–202.
32. Stolpe M, Svanberg K. An alternative interpolation scheme for minimum compliance topology optimization. *Struct Multidiscip Optim* 2001; **22**(2): 116–24.
33. Rozvany GIN. A critical review of established methods of structural topology optimization. *Struct Multidiscip Optim* 2009; **37**(3): 217–37.
34. Kang B-S, Park G-J, Arora JS. A review of optimization of structures subjected to transient loads. *Struct Multidiscip Optim* 2006; **31**(2): 81–95.
35. Arora J. Introduction to optimum design. Elsevier; 2004.
36. Arora RK. Optimization: algorithms and applications. CRC Press; 2015.
37. Galvanetto U, Violaris G. Numerical investigation of a new damage detection method based on proper orthogonal decomposition. *Mech Syst Signal Process* 2007; **21**(3): 1346–61.