

OPTIMAL HYBRID CONTROL OF TALL TUBULAR BUILDINGS USING UPGRADED GAZELLE OPTIMIZATION ALGORITHM WITH CHAOS THEORY

A. Ghaderi¹, M. Nouri^{1,2,*†}, L. Hosseinzadeh¹ and A. Ferdousi^{1,2}

¹*Department of Civil Engineering, Tabriz Branch, Islamic Azad University, Tabriz, Iran.*

²*Robotics & Soft Technologies Research Centre, Tabriz Branch, Islamic Azad University, Tabriz, Iran.*

ABSTRACT

Seismic vibration control refers to a range of technical methods designed to reduce the effects of earthquakes on building structures and many other engineering systems. Most of the recently developed methods in this area have been investigated in vibration suppression of buildings structures each of which have advantages and disadvantages in dealing with complex structural systems and destructive earthquakes. This study aims to implement two of the well-known passive control systems as Base Isolation (BI) and Mass Damper (MD) control as a hybrid control scheme in order to reduce the seismic vibration of tall tubular buildings in dealing with different types of earthquakes. For this purpose, a 50-story tall building is considered with tubular structural system while the hybrid BI-MD control system is implemented in the building for vibration control purposes. Since the parameter tuning process is one of the key aspects of the passive control systems, a metaheuristic-based parameter optimization process is conducted for this purpose in which a new upgraded version of the standard Gazelle Optimization Algorithm (GOA) is proposed as UGOA while the Chaos Theory (CT) is used instead of random movements in the main search loop of the UGOA in order to enhance the overall performance of the standard algorithm. The results show that the upgraded algorithm is capable of conducting better search in dealing with the optimal hybrid control of structural systems.

Keywords: Optimal hybrid control; base isolation; mass damper; gazelle optimization algorithm; structural engineering.

Received: 20 January 2024; Accepted: 17 March 2024

*Corresponding author: Department of Civil engineering, Tabriz Branch, Islamic Azad University, Tabriz, Iran.

†E-mail address: nouri@iaut.ac.ir (M. Nouri)

1. INTRODUCTION

Structural control is the process of response reduction in structural systems in dealing with different types of lateral loads including earthquakes. The use of seismic control systems is one of the recent structural strengthening methods that can be used to control vibration in structures and reduce damage caused by lateral loads. In short, structural control means that by considering the structure as a dynamic system, some of its properties such as stiffness and damping can be adjusted so that the dynamic effects of the force on the structure can be reduced to acceptable levels. Based Isolation (BI) system and Mass Damper (MD) systems are two of the well-known passive energy dissipation devices which have been used for vibration control of structures in recent years [1, 2]. The passive control systems change the stiffness or damping of the structure appropriately without the need for an external energy source. In a passive control system, an external source of power is not needed for the operation of the control system [3]. Wang *et al.* investigated an experimental study for behaviour of MD systems with variable stiffness. Chowdhury *et al.* [5] proposed an enhanced scheme of BI system for vibration control by means of inertial amplifiers. Pietrosanti *et al.* [6] conducted a study for vibration suppression of building structures with MD system. Ghasemi and Talaeitaba [7] utilized BI systems for vibration control of reinforced concrete structures. Wang *et al.* [8] conducted a study in which the effects of soil-structure interaction have been investigated in a building equipped with MD system.

The main purpose of optimization process is to find an acceptable solution among many other feasible solutions, according to the limitations and requirements of the problem. This process can be done with various methods [9] including the metaheuristic algorithms [10] which has been of great interest in recent decades. Since the parameter optimization issue is one of the main concerns in dealing with passive control system, a proper optimization problem should be developed for this purpose. For both of the BI and MD systems, many research works have been conducted for parameter optimization purpose. Jin *et al.* [11] optimized the MD system implemented in floating tunnels for vibration control. Greco and Marano [12] conducted a robust optimization procedure in which the optimum design of BI system is investigated for vibration suppression of purposes. De Domenico *et al.* [13] proposed the idea of using multiple MD systems in vibration control of tall building structures with optimum design procedures. Wang *et al.* [14] utilized stochastic methods for optimum design of BI system for control of building structures. Farshidianfar and Soheili utilized the metaheuristic ant colony method for optimum design of MD control systems for vibration control of tall structures by determining soil-structure interactions. Ocak *et al.* [16] used an adaptive version of the harmony search metaheuristic algorithm for vibration suppression of buildings with BI systems. Ivanov *et al.* [17] conducted seismic optimum design of BI systems for control purposes in different applications. Shi *et al.* [18] utilized the artificial fish swarm metaheuristic algorithm for optimization of MD systems applied for vibration control of pedestrian bridges. Md *et al.* [19] utilized optimization techniques for developing BI systems with low cost in order to control the vibration of masonry buildings. Bandivadekar and Jangid [20] investigated vibration control of structural systems by means of optimal multiple MD systems.

Regarding the fact that the previously implemented control systems in building structures performed acceptable behavior in vibration control of structural systems during recent

earthquakes, the possibility of improving these systems for having better and safer control actions is still one of the main challenges of control experts. The main aim of this paper is to implement two of the well-known passive control systems as Base Isolation (BI) and Mass Damper (MD) control as a hybrid control scheme in order to reduce the seismic vibration of tall tubular buildings in dealing with different types of earthquakes. For this purpose, a 50-story tall building is considered with tubular structural system while the hybrid BI-MD control system is implemented in the building for vibration control purposes. Since the parameter tuning process is one of the key aspects of the passive control systems, a metaheuristic-based parameter optimization process is conducted for this purpose in which a new upgraded version of the standard Gazelle Optimization Algorithm (GOA) [21] is proposed as UGOA while the Chaos Theory (CT) is used instead of random movements in the main search loop of the UGOA in order to enhance the overall performance of the standard algorithm.

2. METAHEURISTIC OPTIMIZATION ALGORITHMS

In this section, the utilized standard and upgraded metaheuristic optimization algorithms are presented. The GOA is selected as the main algorithm while an upgraded version of this algorithm as the UGOA is also proposed for higher-level investigation. For comparative purposes, the Genetic Algorithm (GA) [22], Particle Swarm Optimization (PSO) [23], Harmony Search (HS) Algorithm [24], and Black Hole Algorithm (BHA) [25] are utilized in order to have a valid judgment on the performance of the proposed UGOA.

2.1. Gazelle Optimization Algorithm (GOA)

The gazelle is an elegant and vigilant animal, known for its grace and intelligence. Despite once thriving in large numbers across Africa and Asia, this magnificent creature is now critically endangered, with only a few hundred individuals remaining due to hunting. There are approximately 19 different types of gazelles worldwide, ranging in size from small species like Thomson's and Speke's gazelle to larger ones like the Dama gazelle. Gazelles possess adaptability through their light and swift nature, along with keen senses of hearing, sight, and smell. These adaptive characteristics compensate for their inherent vulnerabilities, enabling them to escape from predators. The unique behaviours and characteristics of gazelles can be observed in their natural habitats (Fig. 1).

Gazelles occupy the second level in the food chain, serving as primary prey for numerous predators. Predators of gazelles include humans, cheetahs, Asiatic and black-backed jackals, spotted hyenas, wild dogs, leopards, and lions. When faced with danger, gazelles communicate warnings to each other by flicking their tail, stomping their feet, or leaping in the air. Leaping with all four feet off the ground up to a height of 2 meters is referred to as "stotting." While the exact purpose of stotting is not fully understood, it is observed when gazelles are nervous or excited. Additionally, to evade predators like cheetahs and lions, gazelles can reach remarkable speeds, reaching up to 100 km/hr. Gazelles can outrun and outmanoeuvre the fastest land predator, the cheetah. The success of most predators depends on their ability to stalk gazelles stealthily, as the gazelles' speed makes it challenging to catch them without the element of surprise.



Figure. 1. Two gazelles in wild life.

The following points highlight the survival methods employed by gazelles, which are used to model the GOA algorithm:

- Point 1: Grazing and running from predators are the most notable aspects.
- Point 2: Grazing behaviour, in the absence of predators, can be exploited.
- Point 3: Predators stalk gazelles while they graze.
- Point 4: Gazelles utilize stotting, among other behaviours, to detect predators.
- Point 5: Stotting can reach a height of 2 meters.
- Point 6: The ability to outrun spotted predators and reach safety can be utilized.
- Point 7: Gazelles cannot outrun the fastest predator

The GOA is an optimization algorithm that utilizes a population of randomly initialized gazelles (X) as search agents. These search agents are represented as a matrix of candidate solutions, where each solution is defined by an $n \times d$ matrix, as follows:

$$X = \begin{bmatrix} x_{11} & x_{12} & \cdots & x_{1j} & \cdots & x_{1d} \\ x_{21} & x_{22} & \cdots & x_{2j} & \cdots & x_{2d} \\ \vdots & \vdots & & \vdots & \ddots & \vdots \\ x_{i1} & x_{i2} & \cdots & x_{ij} & \cdots & x_{id} \\ \vdots & \vdots & & \vdots & \ddots & \vdots \\ x_{n1} & x_{n2} & \cdots & x_{nj} & \cdots & x_{nd} \end{bmatrix} \quad (1)$$

$$x_{ij} = rand \times (UB_j - LB_j) + LB_j, \quad j = 1, 2, \dots, n, \quad (2)$$

where X represents the matrix containing the position vectors of the candidate population; x_{ij} denotes the randomly generated vector position of the i th population in the j th dimension; $rand$ is a random number in the range of 0 and 1.

The minimum solution found so far is considered the best solution obtained. In nature, the fittest gazelles are known for their ability to spot danger, communicate it to others, and

escape from predators. Therefore, the best solution obtained thus far is referred to as the top gazelle and is used to construct an Elite matrix as follows while x_{ij}^J is the position of the top gazelle:

$$Elite = \begin{bmatrix} x_{11}^J & x_{12}^J & \cdots & x_{1j}^J & \cdots & x_{1d}^J \\ x_{21}^J & x_{21}^J & \cdots & x_{2j}^J & \cdots & x_{2d}^J \\ \vdots & \vdots & & \vdots & \ddots & \vdots \\ x_{i1}^J & x_{i2}^J & \cdots & x_{ij}^J & \cdots & x_{id}^J \\ \vdots & \vdots & & \vdots & \ddots & \vdots \\ x_{n1}^J & x_{n2}^J & \cdots & x_{nj}^J & \cdots & x_{nd}^J \end{bmatrix} \quad (3)$$

The GOA emulates the survival behaviour of gazelles and consists of two distinct phases to optimize the process. The first phase, known as exploitation, occurs when the gazelles are grazing peacefully without any predator nearby or while being stalked by a predator. During this phase, the gazelles move in a Brownian motion characterized by controlled and uniform steps, allowing them to effectively explore the neighbouring areas of the domain (Fig. 2). The grazing behaviour of the gazelles is modelled using the following equation:

$$gazelle_{i+1} = gazelle_i + s, R \times, R_B \times, (Elite_i - R_B \times, gazelle_i) \quad (4)$$

where $gazelle_i$ represents the solution at the next iteration, $gazelle_{i+1}$ denotes the solution at the current iteration, s represents the grazing speed of the gazelles, R_B is a vector containing random numbers representing the Brownian motion, and R is a vector of uniform random numbers between 0 and 1.

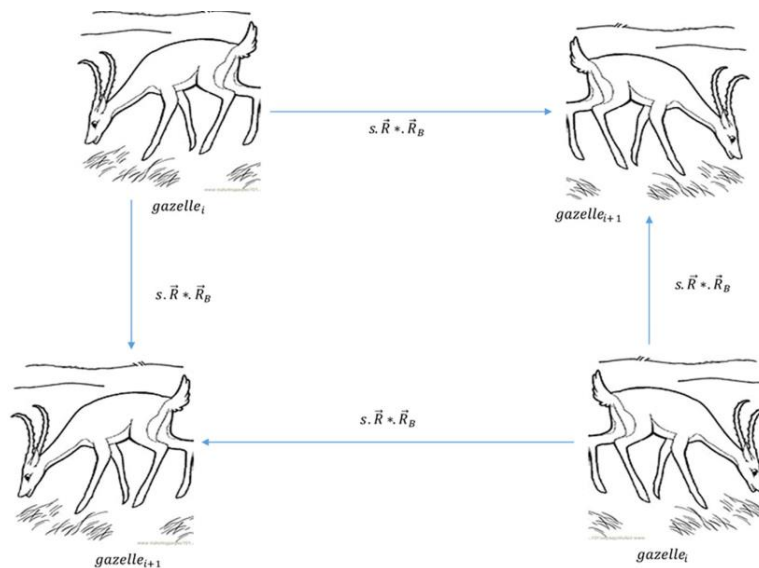

Figure 2. The grazing behaviour exhibited by the gazelles in the exploitation phase.

The second phase, known as exploration, begins when a predator is sighted. In response to the danger, the gazelles exhibit defensive behaviours such as tail flicking, foot stomping, or stotting (a behaviour where all four feet leave the ground and a height of 2 m is scaled to a value between 0 and 1). This phase employs a Levy flight, which involves taking small steps interspersed with occasional long jumps as follows:

$$\overrightarrow{gazelle}_{i+1} = \overrightarrow{gazelle}_i + S, \mu, \vec{R} \times, \vec{R}_L \times, (\overrightarrow{Elite}_i - \vec{R}_L \times \overrightarrow{gazelle}_i) \tag{5}$$

$$\overrightarrow{gazelle}_{i+1} = \overrightarrow{gazelle}_i + S, \mu, CF \times, \vec{R}_B \times, (\overrightarrow{Elite}_i - \vec{R}_L \times \overrightarrow{gazelle}_i) \tag{6}$$

$$CF = \left(1 - \frac{iter}{Max_iter}\right)^{\left(2 \frac{iter}{Max_iter}\right)} \tag{7}$$

In these equations, *S* represents the maximum speed that a gazelle can achieve, and *R_L* represents a vector of randomly generated numbers following a Levy distribution.

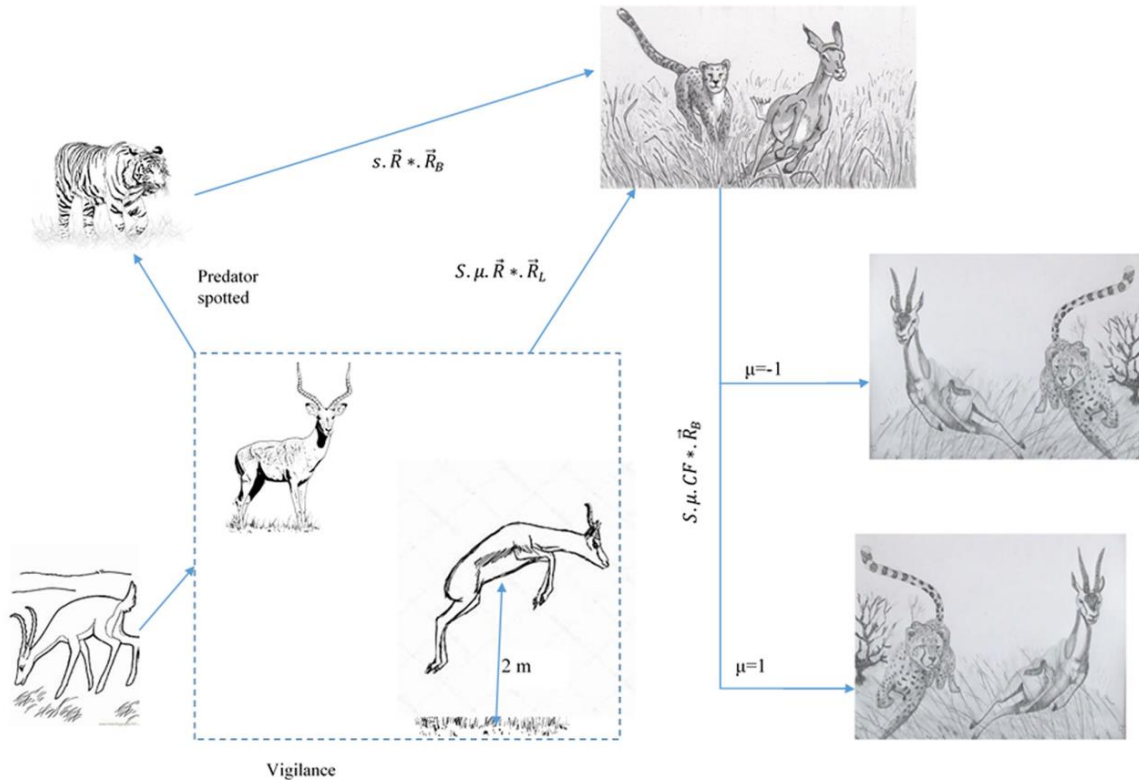

Figure 3. Escaping behaviour of gazelles in the exploration phase.

Based on the reported data in literature, the gazelles have an annual survival rate of 0.66 so that predators are only successful in capturing gazelles 34% of the time. The exploitation phase of the GOA simulates the peaceful grazing behaviour of gazelles when there is no predator present or while the predator is stalking them. Once a predator is spotted, the GOA transitions into the exploration phase. During this phase, the gazelle's ability to escape is influenced by its effectiveness in outrunning and outmanoeuvring the predator, ensuring that the algorithm avoids getting trapped in a local minimum. The predator success rates (PSRs) impact this ability and are modelled as follows:

$$\vec{gazelle}_{i+1} = \begin{cases} \vec{gazelle}_i + CF[\vec{LB} + \vec{R} \times (\vec{UB} - \vec{LB})] \times \vec{U} & \text{if } r \leq PSRs \\ \vec{gazelle}_i + [PSRs(1 - r) + r](\vec{gazelle}_{r1} - \vec{gazelle}_{r2}) & \text{else} \end{cases} \quad (8)$$

$$\vec{U} = \begin{cases} 0 & \text{if } r < 0,34 \\ 1 & \text{otherwise} \end{cases} \quad r1 \text{ and } r2 \text{ are random indexes of the gazelle matrix} \quad (9)$$

where r is a random number in the range of 0 and 1. The flowchart of the GOA is presented in Fig. 4.

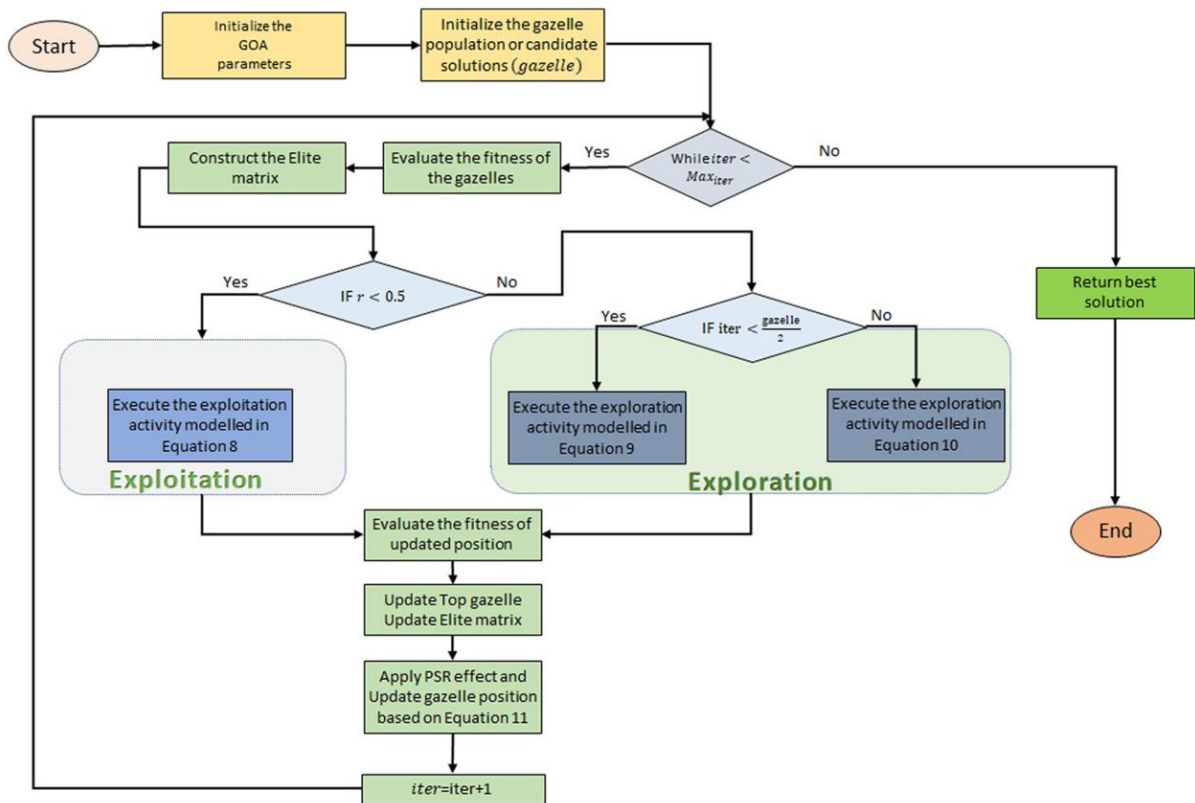

Figure 4. Flowchart of the GOA

2.2. Upgraded Gazelle Optimization Algorithm (UGOA)

Chaos Theory (CT) is an interdisciplinary scientific theory that tries to express the underlying patterns of complex phenomena in simple language. Chaotic systems have large attractors or abductors, which form elliptical or circular orbits. These circuits never repeat in exactly the same way as before, but they limit the state space. Lorenz, who was a meteorologist, realized in 1991 that when he was repeating simulations of atmospheric patterns, a very small (decimal) change in a simulation equation changed the results of the sequences with the patterns. His discovery is known as the "butterfly effect", which can be explained as follows: the rotation of a butterfly in New Zealand may cause a storm in the Amazon forests.

Chaos theory tries to describe the world using non-linear dynamics. On the other hand, the theory of complexity claims that the world is "a model of complex systems" that relies on self-organizing through a rapid transition from chaos to order. The main achievement of chaos theory is its ability to express the relationships of simple sets that can provide a pattern for unpredictable outcomes. Chaotic systems, while limiting outcomes and creating patterns with mathematical constants, never return to their original state. This promises to find the possibility of understanding the fundamental order and structure hidden in the heart of complex physical and social phenomena.

In order to improve the performance of the GOA as a recently developed optimization algorithm, the chaos theory is utilized in such a way that the formulation the chaotic maps are implemented in the main loop of the algorithm to enhance its behaviour in dealing with optimization process. In this regard, 10 chaos theory maps (Table 1) are used in the UGOA algorithm, so that all the random maps needed in the special relativity search algorithm are replaced with the chaos theory maps (Fig. 5).

Table 1. Mathematical formylation of chaotic maps [26].

No.	Name	Chaotic map	Range
1	Chebyshev	$x_{i+1} = \cos(\text{icos}^{-1}(x_i))$	(-1,1)
2	Circle	$x_{i+1} = \text{mod}\left(x_i + b - \left(\frac{a}{2\pi}\right) \sin(2\pi x_k), 1\right)$. $a = 0,5$ and $b = 0,2$	(0,1)
3	Guss/mouse	$x_{i+1} = \begin{cases} 1 & x_i = 0 \\ \frac{1}{\text{mod}(x_i,1)} & \text{otherwise} \end{cases}$	(0,1)
4	Iterative	$x_{i+1} = \sin\left(\frac{a\pi}{x_i}\right)$, $a=0.7$	(-1,1)
5	Logistic	$x_{i+1} = ax(1 - x)$, $a=4.0$	(0,1)
6	Piecewise	$x_{i+1} = \begin{cases} \frac{x_i}{P} & 0 \leq x_i < P \\ \frac{x_i - P}{0,5 - P} & P \leq x_i < 0,5 \\ \frac{1 - P - x_i}{0,5 - P} & 0,5 \leq x_i < 1 - P \\ \frac{1 - x_i}{P} & 1 - P \leq x_i < 1 \end{cases}$. $P = 0,4$	
7	Sine	$x_{i+1} = \frac{a}{4} \sin(\pi x_i)$, $a=4.0$	(0,1)
8	Singer	$x_{i+1} = \mu(7,86x_i - 23,3x_i^2 + 28,75x_i^3 - 13,302875x_i^4)$, $\mu = 1,07$	(0,1)
9	Sinusoidal	$x_{i+1} = ax_i^2 \sin(\pi x_i)$, $a=2.3$	(0,1)

10 Tent
$$x_{i+1} = \begin{cases} \frac{x_i}{0,7} & x_i < 0,7 \\ \frac{10}{3}(1 - x_i) & x_i \geq 0,7 \end{cases} \quad (0,1)$$

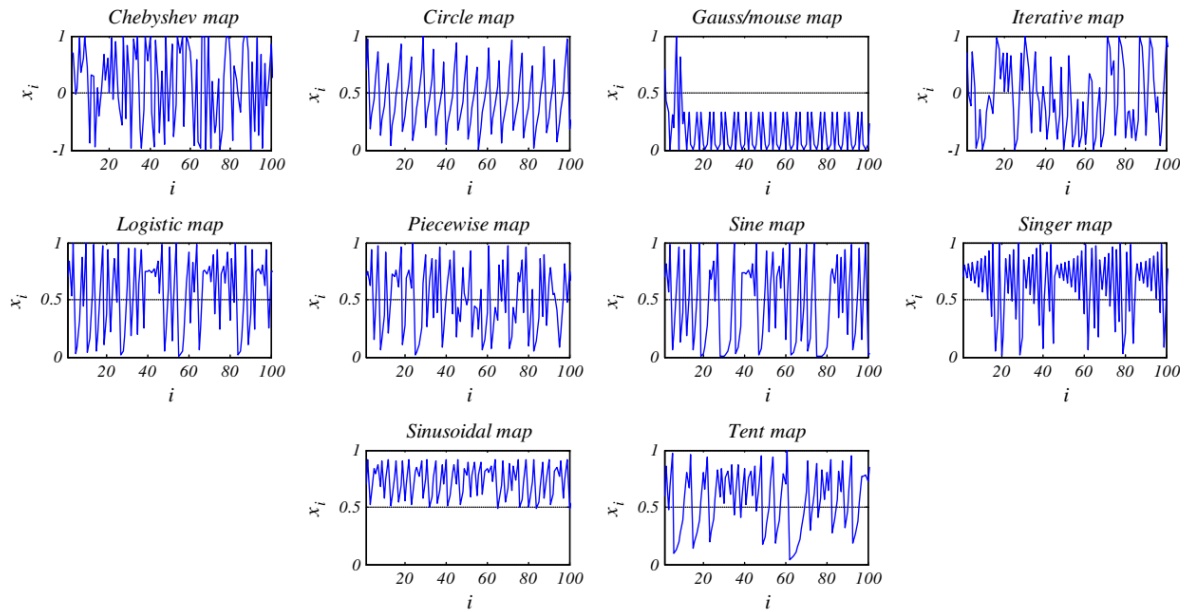

Figure 5. The graphs of chaotic maps

3. STATEMENT OF OPTIMIZATION PROBLEM

Human beings want to visualize, describe and achieve the best in dealing with most of the challenges in the world; however, it is not possible to identify and define all the conditions governing the best. For this purpose and in most of the cases, a satisfactory answer instead of the best answer is considered as the main goal to be satisfied. Optimization is the process of making judgmental decisions regarding a predefined problem in which maximization or minimization of an objective is considered. In the comparison of optimization algorithms, two criteria of convergence and performance are proposed. Some algorithms have better convergence behavior, but they may have poor performance, that is, their improvement process does not have the necessary efficiency and speed. Unlike some other algorithms, there is no convergence, but their performance is very good. For developing any optimization process, an optimization problem should be defined which is comprised of objective function, decision variables determined by considering the bound constraints and design constraints.

3.1. Optimum Hybrid Control

This section outlines the development of the optimization problem for controlling vibrations in a building structure through a combination of MD and BI systems. The

formulation provides a clear definition of the key elements involved in the optimization problem, such as the objective, variables, and constraints.

3.1.1. Optimization Variables

As one of the most popular passive energy dissipation devices, an MD system is comprised of a spring, a damper and added mass. For optimization purpose, each MD system in each floor of the structure has three parameters as m_{MD} for mass, k_{MD} for stiffness and c_{MD} for damping. The following equations show the mathematical presentation of the MD system's parameters:

$$m_{MD} = m_0 \times m_{Building} \quad (10)$$

$$k_{MD} = m_{MD} \times (\beta \times \omega_1)^2 \quad (11)$$

$$c_{MD} = 2 \times \xi_{MD} \times \sqrt{k_{MD} \times m_{MD}} \quad (12)$$

For each MD system in each floor, the forth parameter is an integer variable which demonstrate the existence of the MD system in the floor. During the optimization, three optimization variables should be determined as m_0 , β and ζ_{MD} alongside the existence variable. In the above equations, $m_{Building}$ is the mass of the considered structure, ω_1 is the main frequency of the structure while m_{MD} , k_{MD} and c_{MD} are the mass, stiffness and damping of the MD system.

For BI system, the stiffness (k_{BI}) and damping (c_{BI}) of the BI system should be determined for the whole building structure while two variables β and ζ_{BI} should be optimized. The following equations show the mathematical presentation of the BI system's parameters:

$$k_{BI} = m_{Building} \times (\beta \times \omega_1)^2 \quad (13)$$

$$c_{BI} = 2 \times \xi_{BI} \times \sqrt{k_{BI} \times m_{Building}} \quad (14)$$

In the above equations, $m_{Building}$ is the mass of the considered structure, ω_1 is the main frequency of the structure while k_{BI} and c_{BI} are the mass, stiffness and damping of the BI system.

This paper focuses on a hybrid control approach for building structures, where both MD (Mass Damper) and BI (Base Isolation) systems are utilized. The optimization problem involves determining a total of $((N_{st}+1) \times 4) + 2$ variables, where N_{st} represents the number of

stories in the building being considered. It should be noted that the foundation level of the structure, which is also incorporated into the seismic isolator system, allows for the possibility of including a mass damper at this level in the optimization problem. Fig. 6 provides a schematic illustration of the hybrid control approach, combining BI and MD systems.

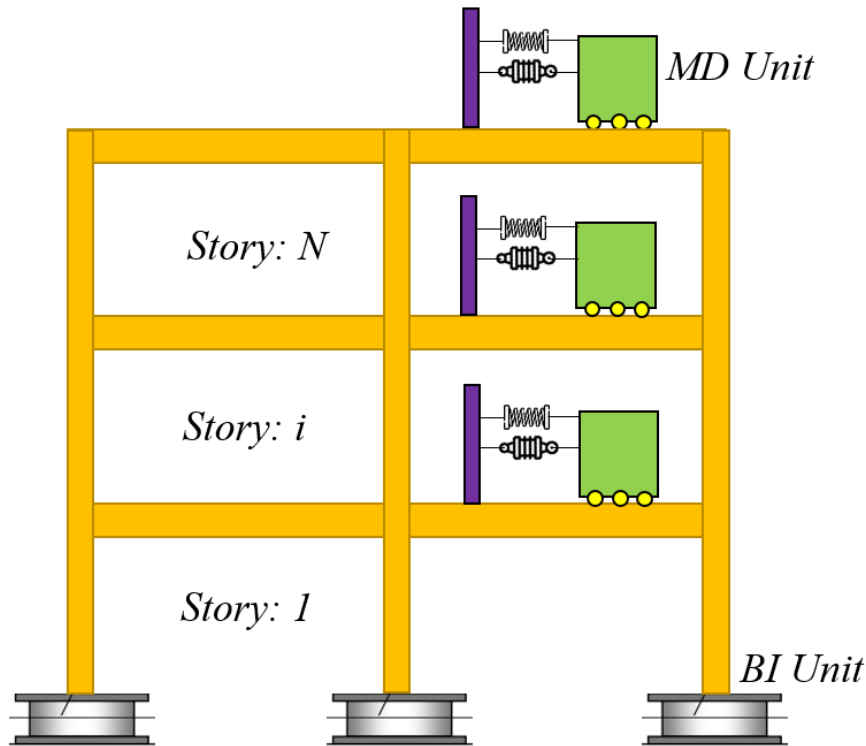

Figure. 6. Schematic presentation of the hybrid control approach by means of BI and MD

3.1.2. Optimization Constraints

The bound constraints including the upper and lower bounds of the decision variables are determined in this section which are summarized in Tables 2 and 3 for the MD and BI systems respectively.

Table 2. Upper and lower bounds of decision variables for MD system

Variables' Number	Parameters of MD system	Boundaries
Variable 1	m_0	[1% - 8%]
Variable 2	β	[0.5 - 1.5]
Variable 3	ζ_{MD}	[1% - 30%]
Variable 4	Presence or Absence	0 or 1

Table 3. Upper and lower bounds of decision variables for BI system

Variables' Number	Parameters of MD system	Boundaries
Variable 5	β	[0.5 - 2]
Variable 6	ζ_{BI}	[1% - 50%]

3.1.3. Objective Function

During the optimization process, the controlled response of the structure equipped with hybrid MD-BI control system is reduced while the objective function is developed based on the ratio of this response to the response of the structure without control device. For time history structural analysis purposes, 7 acceleration records of Tabas, Lomaprieta, Manjil, Chi Chi, Imperial Valley, Duzce and El Centro earthquakes are used (Table 4).

Table 4. Characteristics of selected seismic records

Abr.	Earthquake	M_w	R (km)	Station	Component	PGA (m/s ²)	PGV (cm/s)	PGD (cm)
EQ1	Tabas	7.35	2.05	Tabas	T1	8.45	1210.11	917.96
EQ2	Lomaprieta	6.93	3.85	CLS	CLS000	6.32	548.82	92.59
EQ3	Manjil	7.37	12.55	Abbar	T	4.87	496.09	233.41
EQ4	Chi Chi	7.62	3.12	CHY	CHY028	6.24	602.01	199.13
EQ5	Imperial Valley	6.53	2.66	BCR	BCR140	5.87	458.43	198.26
EQ6	Duzce	7.14	12.04	BOL	BOL090	7.90	646.04	128.38
EQ7	Elcentro	6.9	-	Irrigation District	El-180	3.42	38.11	232.61

In order to consider the response of the structure by means of all 7 earthquake records, a single-objective optimization problem through the use of the weighted sum method is formulated in this study by using the Peak Ground Acceleration (PGA) of the mentioned as the weighting coefficients. The value of the objective function is calculated as follows:

Obj

$$= \frac{8,45 \times \left(\frac{CR}{UR}\right)_{Tabas} + 6,32 \times \left(\frac{CR}{UR}\right)_{Lomap} + 4,87 \times \left(\frac{CR}{UR}\right)_{Manjil} + 6,24 \times \left(\frac{CR}{UR}\right)_{ChiChi} + 5,87 \times \left(\frac{CR}{UR}\right)_{Imperial} + 7,90 \times \left(\frac{CR}{UR}\right)_{Duzce} + 3,42 \times \left(\frac{CR}{UR}\right)_{Elcentro}}{(8,45 + 6,32 + 4,87 + 6,24 + 5,87 + 7,90 + 3,42)} \quad (15)$$

where CR and UR are the controlled and uncontrolled response of the structural system in the roof floor for different earthquakes, respectively.

Other methods for active control of structures can be found in [30-33], and different efficient metaheuristics are presented by Kaveh in [34-35].

4. DESIGN EXAMPLE

For numerical analysis purposes, a 50-story tall building structure is considered while the main lateral load resisting system of this building is tubular moment frames (Fig. 4). In order to implement the hybrid control scheme into this structure, the processes of analysis and design should be conducted for this building based on the recent codes and regulations. For this aim, the weight per unit volume for various materials and common building materials is determined according to Appendix 6 of the National Building Regulations [27]. To be specific, the dead load for standard floors and roofs in this building (perimeter area) is 550 kg/m^2 , while the live load for standard floors and roofs in perimeter area is 250 kg/m^2 and 150 kg/m^2 respectively. The dead load for standard floors and roofs in this building (core area) is 505 kg/m^2 and 570 kg/m^2 respectively, while the live load for standard floors and roofs in core area is 150 kg/m^2 . The seismic load is calculated based on the fourth edition of Iranian Standard 2800 [28]. The buildings are located in a region with a significantly high relative risk, classified as class III ground according to the fourth edition of Standard 2800. The design of moment-resisting elements follows the guidelines of the 10th National Building Regulations for the design and construction of concrete buildings [29]. The specifications of the materials used in the structural model are provided in Table 5.

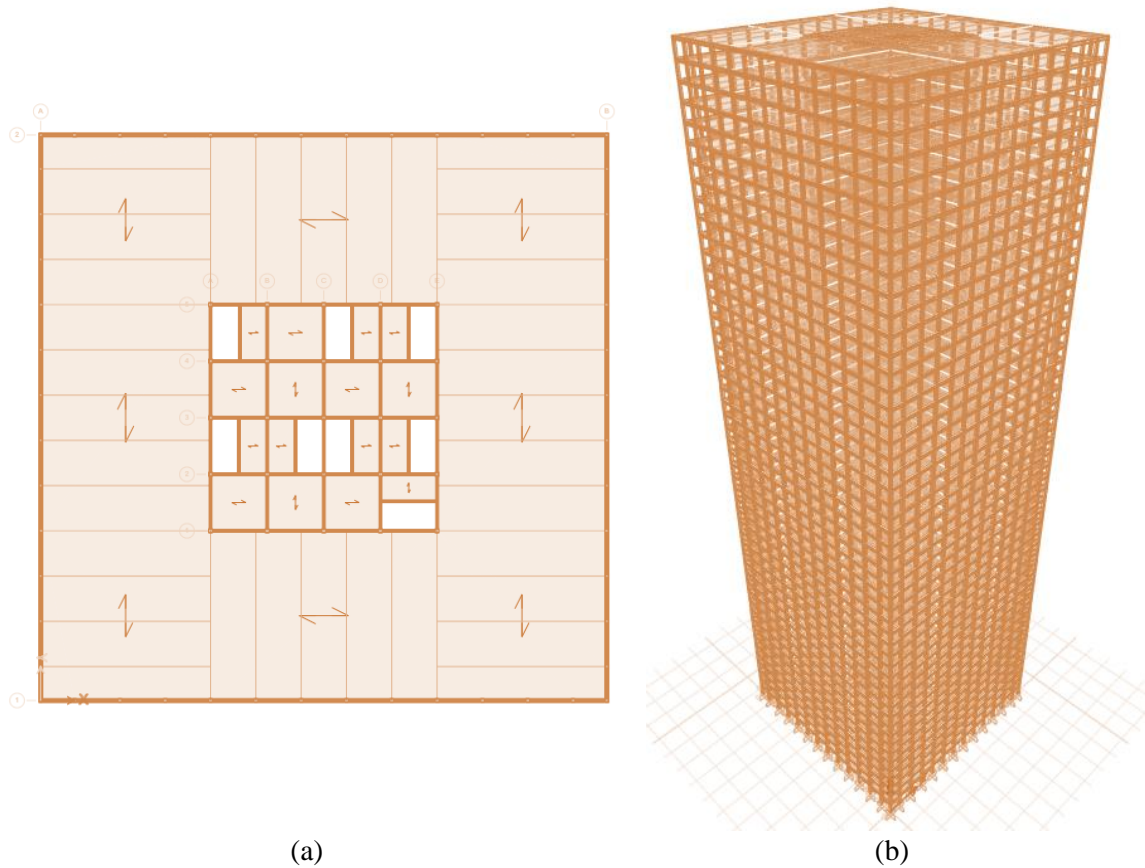

Figure 4. (a) Plan, and (b) 3D view of the 50-story building structure.

Table 5. Characteristics of utilized material in steel elements

Property	Amount
Unit weight of steel	$\gamma = 2500 \text{ kgf} / \text{m}^3$
Steel Yield Strength	$f_c = 250 \text{ kgf} / \text{m}^2$
Ultimate Tensile Strength	$\nu = 0.2$
Steel Poisson's Ratio	$E = 2.1 \times 10^5 \text{ kgf} / \text{cm}^2$

5. NUMERICAL INVESTIGATIONS

Based on the conducted optimization procedures regarding the optimum hybrid control of 50-story tall tubular building structure, the results of the numerical investigations are presented in this section.

5.1. Convergence Curves

By considering the objective function as the ration of the controlled response of the structure equipped with hybrid MD-BI control system and the response of the structure without control device, the convergences curves of the GOA and other alternative algorithms are depicted in Fig. 5. It can be seen that GOA is capable of providing better optimum results than the other methods.

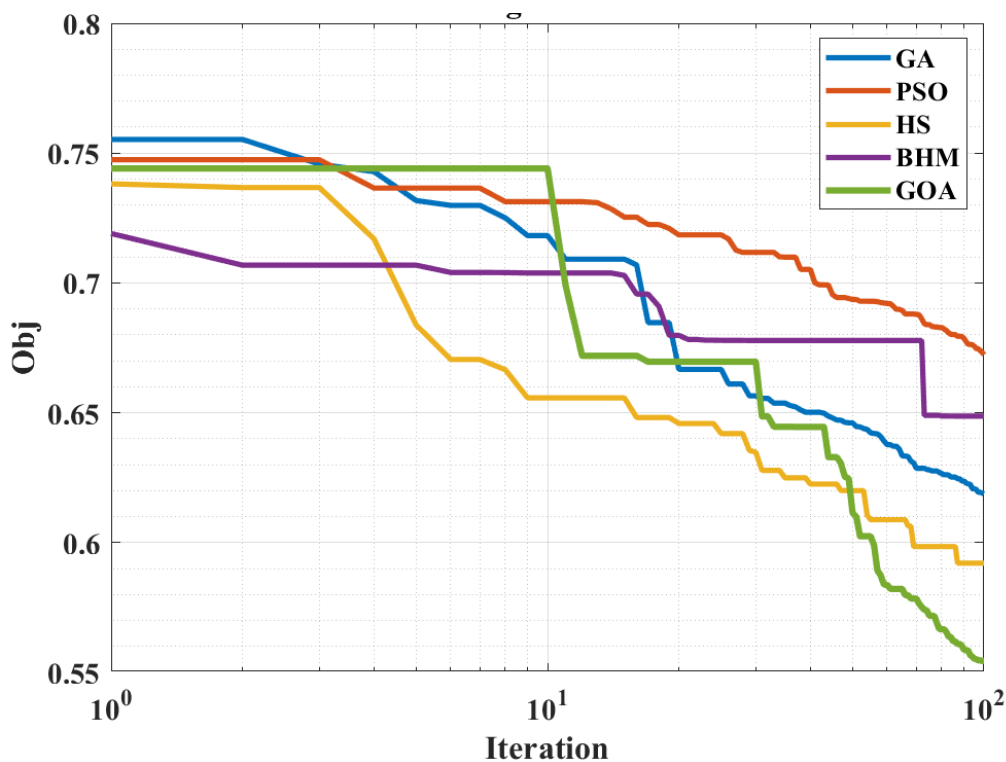

Figure 5. Convergence curves of GOA and other algorithms

By evaluating the optimum results of the GOA and other alternative algorithms in Table 6, the GOA is capable of reaching 0.5544 which is the best among other approaches. This means that by working on the main search loop of this algorithm, there is a possibility to reach better results.

Table 6. Optimal response values calculated by GOA and alternative algorithms

Metaheuristic Algorithms	Ratio of controlled response to uncontrolled response (objective function value)
GA	0.6188
PSO	0.6723
HS	0.5921
BHA	0.6487
<u>GOA</u>	<u>0.5544</u>

By implementing different types of chaotic maps into the standard GOA, the convergence behaviour of the algorithm is improved while the UGOA is capable of reaching better results than the GOA in all of the chaotic maps (Fig. 6).

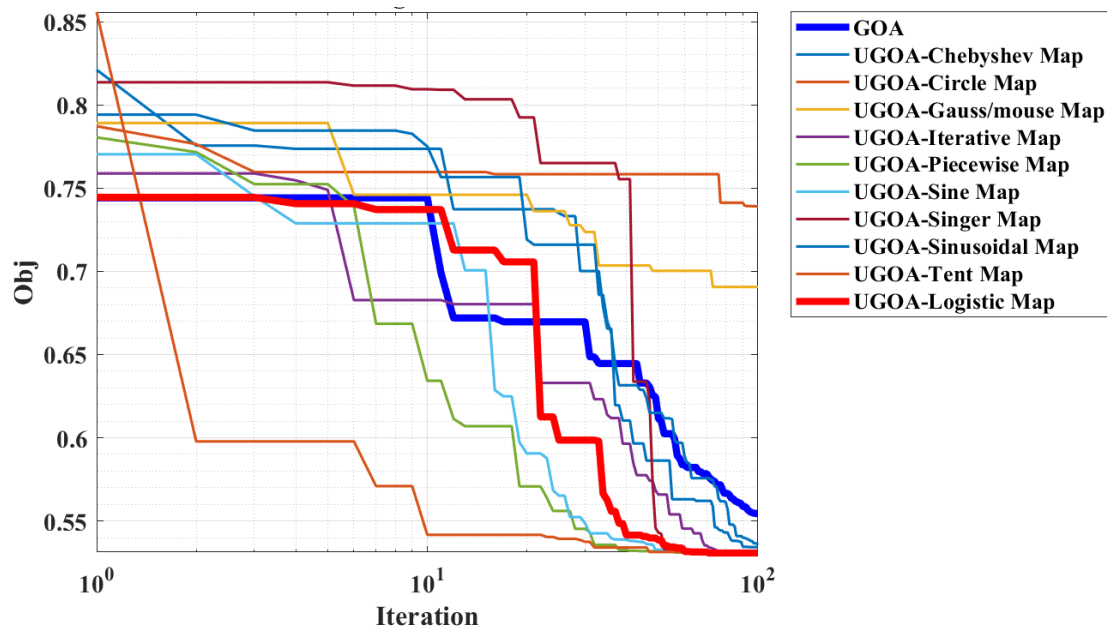

Figure 6. Convergence curves of the GOA and UGOA combined with chaos theory mappings

By evaluating the results in Table 7 which are the best optimum results of optimization procedures conducted by GOA and UGOA algorithm with chaotic maps, it is concluded that

UGOA with Logistic Chaotic Map is capable of reaching 0.530758 which is the best among other results of chaotic maps.

Table 7. Optimal response values calculated by UGOA algorithm with different chaotic maps

Metaheuristic Algorithms with Chaotic Maps	Ratio of controlled response to uncontrolled response (objective function value)
GOA	0.554418
UGOA-Chebyshev Map	0.534199
UGOA-Circle Map	0.739018
UGOA-Gauss/mouse Map	0.690624
UGOA-Iterative Map	0.530764
<u>UGOA-Logistic Map</u>	<u>0.530758</u>
UGOA-Piecewise Map	0.530764
UGOA-Sine Map	0.530764
UGOA-Singer Map	0.530763
UGOA-Sinusoidal Map	0.535488
UGOA-Tent Map	0.531337

5.2. Structural Responses

It should be noted that the optimum hybrid control approach is capable of reducing the objective function by up to 48% by means of UGOA algorithm combined with Logistic Chaotic Map. Since the optimum hybrid approach is capable of reducing the response of the structure which is considered in the objective function, the structural responses of the last floor (roof) of the 50-story structure have been extracted in the case of using the UGOA algorithm upgraded with Logistic Chaotic Map in Table 8. The UGOA is capable of reducing the response of the structure by up to 57% in dealing with the Duzce earthquake which indicates the acceptable performance of this upgraded algorithm.

Table 8. The optimal response of the UGOA algorithm improved with Logistic Chaotic Map for a 50-story building considering different earthquakes

Earthquakes	Uncontrolled response (maximum roof floor displacement)	Controlled response (Maximum roof floor displacement)	Ratio of controlled response to uncontrolled response
Tabas	2.7511	1.2219	0.4442
Lomapieta	0.1777	0.0923	0.5194
Manjil	0.5917	0.2809	0.4748
Chi Chi	0.4785	0.2153	0.4498
Imperial Valley	0.4614	0.2204	0.4777
Duzce	<u>0.2955</u>	<u>0.1296</u>	<u>0.4387</u>
Elcentro	0.4309	0.3668	0.8512

In Fig. 7, the drift ratios of the 50-story tall tubular building structure are depicted for 4 states as uncontrolled structure, controlled structure with MD and BI systems alongside controlled structure by optimal hybrid approach designed by UGOA. It can be seen that the

combined control system has a better performance than the individual control systems.

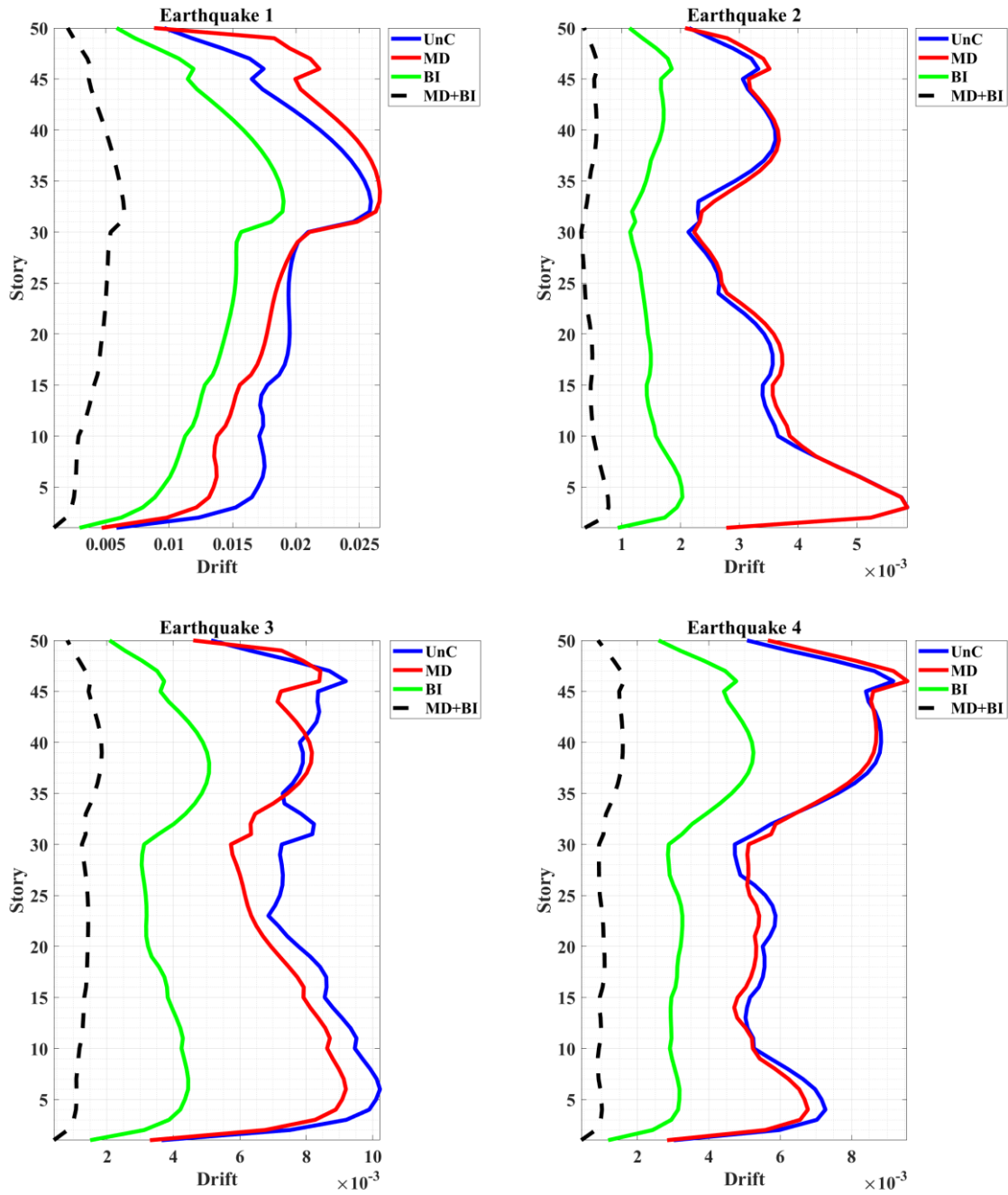

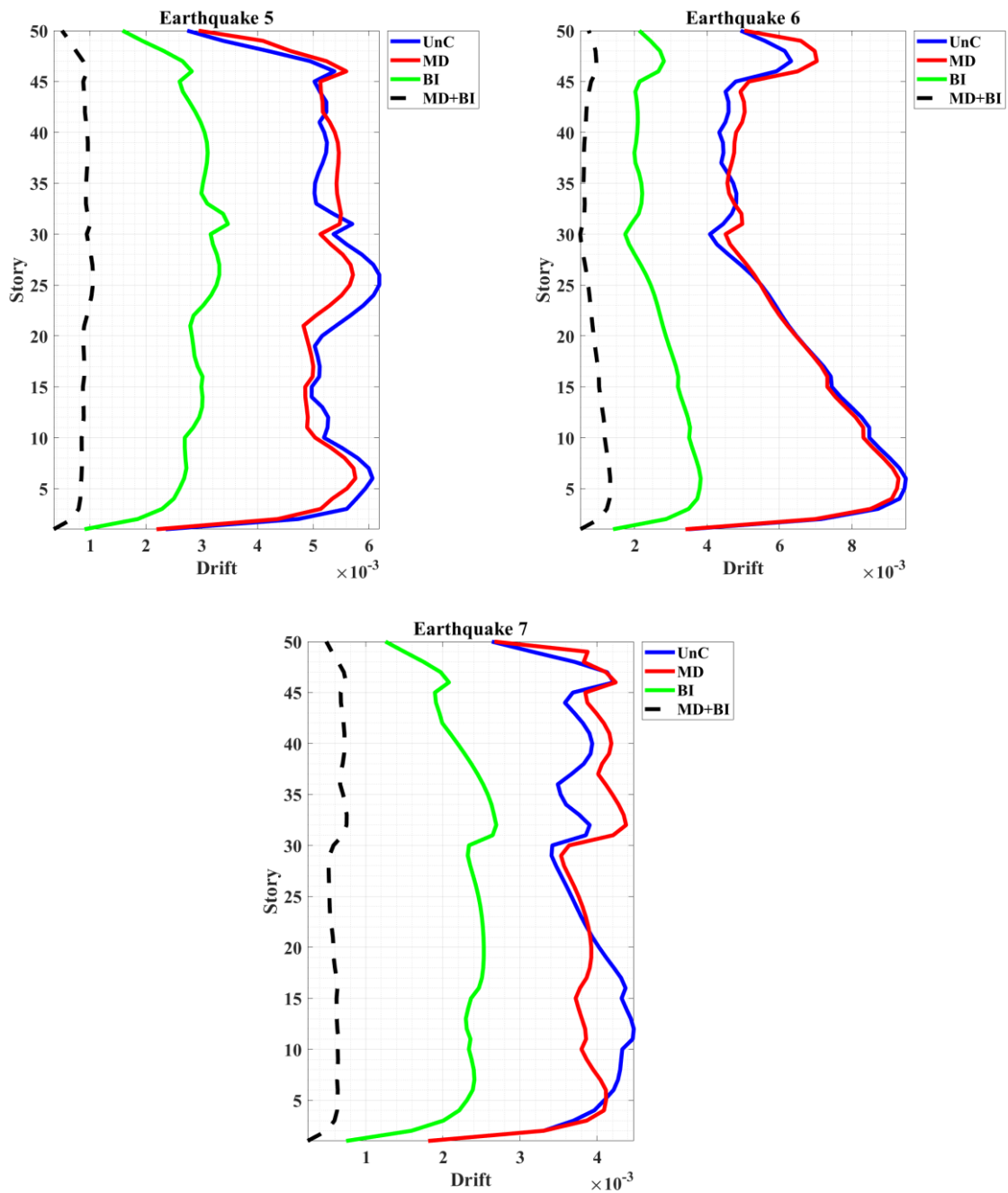

Figure 7. Draft ratios of the 50-story tubular structure using the UGOA algorithm in 4 states.

5.3. Optimal values of decision variables

Regarding the fact that the UGOA algorithm enhanced with Logistic chaos mapping is capable of tuning the decision variables of m_0 , β and ζ_{tmd} for the MD system and β and ζ_{BI} for BI system in successive iterations to reduce the objective function, which is the

maximum ratio of the controlled response of the structure to the uncontrolled responses. The optimal values of these variables in the last iteration of the optimization process conducted by UGOA enhanced with Sine Map chaos mapping are presented in Table 9.

Table 9. Optimum values of optimization variables for different control modes

Type of Variables	Specification of Variables	MD Control System	BI Control System	Hybrid Control of MD+BI
MD	m_0	6%	-	1%
	β	1	-	0.8
	ζ_{MD}	25%	-	10%
BI	β	-	1.2	0.097
	ζ_{BI}	-	20%	80%

It is worth noting that in the state of optimal hybrid control of the structure, the UGOA algorithm with Logistic chaos mapping has considered the number of one mass damper for the structure (roof floor) whose specifications are mentioned in the table above.

6. CONCLUSIONS

The main aim of this paper is to implement two of the well-known passive control systems as Base Isolation (BI) and Mass Damper (MD) control as a hybrid control scheme in order to reduce the seismic vibration of tall tubular buildings in dealing with different types of earthquakes. For this purpose, a 50-story tall building is considered with tubular structural system while the hybrid BI-MD control system is implemented in the building for vibration control purposes. Since the parameter tuning process is one of the key aspects of the passive control systems, a metaheuristic-based parameter optimization process is conducted for this purpose in which a new upgraded version of the standard Gazelle Optimization Algorithm (GOA) is proposed as UGOA while the Chaos Theory (CT) is used instead of random movements in the main search loop of the UGOA in order to enhance the overall performance of the standard algorithm. The results of this paper are as follows:

By analysing the convergence history of the GOA algorithm and other metaheuristic algorithms, the GOA algorithm demonstrates its capability to converge to the optimal solution for the selected objective function in the hybrid MD-BI control system, achieving a value of 0.5544.

Among 10 chaotic maps, the UGOA algorithm enhanced with the Logistic Chaotic Map yields the most favourable objective function value compared to other chaotic maps and even the standard GOA algorithm.

The UGOA algorithm, upgraded with the Logistic chaos mapping, exhibits superior optimization performance, attaining a value of 0.5307 for the objective function, which outperforms all other chaotic cases.

When applied to the 50-story structure's last floor (roof), the UGOA algorithm enhanced with Logistic chaos mapping demonstrates decreased structural responses across all 7 earthquake records. Notably, it achieves a significant 57% reduction in response during the Duzce earthquake, indicating the upgraded algorithm's commendable performance.

REFERENCES

1. Yang F, Sedaghati R, Esmailzadeh E. Vibration suppression of structures using tuned mass damper technology: A state-of-the-art review. *J Vib Cont.* 2022;**28**(7-8):812-36.
2. Sheikh H, Van Engelen NC, & Ruparathna R. A review of base isolation systems with adaptive characteristics. In *Structures*, 2022; **38**:1542-55.
3. Hagedorn P, Spelsberg-Korspeter G, editors. *Active and passive vibration control of structures*. New York: Springer; 2014 Oct 20.
4. Wang L, Nagarajaiah S, Zhou Y, Shi W. Experimental study on adaptive-passive tuned mass damper with variable stiffness for vertical human-induced vibration control. *Eng Struct.* 2023 Apr 1;**280**:115714.
5. Chowdhury S, Banerjee A, Adhikari S. Enhanced seismic base isolation using inertial amplifiers. In *Structures* 2021 Oct 1; **33**: 1340-53.
6. Pietrosanti D, De Angelis M, Basili M. A generalized 2-DOF model for optimal design of MDOF structures controlled by Tuned Mass Damper Inerter (TMDI). *Int J Mech Sci.* 2020 Nov 1;**185**:105849.
7. Ghasemi M, Talaeitaba SB. On the effect of seismic base isolation on seismic design requirements of RC structures. In *Structures* 2020 Dec 1; **28**: 2244-59. Elsevier.
8. Wang L, Shi W, Zhou Y. Adaptive-passive tuned mass damper for structural aseismic protection including soil–structure interaction. *Soil Dynamics and Earthquake Engineering.* 2022 Jul 1;**158**:107298.
9. Jin Y, Wang H, Sun C, Jin Y, Wang H, Sun C. Classical optimization algorithms. *Data-Driven Evolutionary Optimization: Integrating Evolutionary Computation, Machine Learning and Data Science*; 2021:41-51.
10. Yang XS. Metaheuristic optimization: algorithm analysis and open problems. In *Experimental Algorithms: 10th International Symposium, SEA 2011, Kolimpari, Chania, Crete, Greece, May 5-7, 2011. Proceedings 10 2011 (pp. 21-32)*. Springer Berlin Heidelberg.
11. Jin C, Chung WC, Kwon DS, Kim M. Optimization of tuned mass damper for seismic control of submerged floating tunnel. *Engineering Structures.* 2021 Aug 15;**241**:112460.
12. Greco R, Marano GC. Robust optimization of base isolation devices under uncertain parameters. *J Vib Cont.* 2016 Feb;**22**(3):853-68.
13. De Domenico D, Qiao H, Wang Q, Zhu Z, Marano G. Optimal design and seismic performance of Multi-Tuned Mass Damper Inerter (MTMDI) applied to adjacent high-rise buildings. *Struct Des Tall Special Build.* 2020 Oct 10;**29**(14):e1781.
14. Wang H, Shen W, Zhu H, Luo H. Stochastic optimization of a nonlinear base isolation system with LRB and EIMD for building structures. *Struct Cont Health Monit.* 2023 Feb 7;2023.
15. Farshidianfar A, Soheili S. Ant colony optimization of tuned mass dampers for earthquake oscillations of high-rise structures including soil–structure interaction. *Soil Dynam Earthq Eng.* 2013 Aug 1;**51**:14-22.

16. Ocak A, Nigdeli SM, Bekdaş G, Kim S, Geem ZW. Optimization of Seismic Base Isolation System Using Adaptive Harmony Search Algorithm. *Sustainability*. 2022 Jun 18;**14**(12):7456.
17. Ivanov AY, Chernogorskiy SA, Vlasov MP. Seismic design optimization considering base-isolation system. *Magaz Civil Eng*. 2018;**4**(80):138-50.
18. Shi W, Wang L, Lu Z, Zhang Q. Application of an artificial fish swarm algorithm in an optimum tuned mass damper design for a pedestrian bridge. *Appl Sci*. 2018 Jan 25;**8**(2):175.
19. Md ZN, Mohan SC, Jyosyula SK. Development of low-cost base isolation technique using multi-criteria optimization and its application to masonry building. *Soil Dynam Earthq Eng*. 2023 Sep 1;**172**:108024.
20. Bandivadekar TP, Jangid RS. Optimization of multiple tuned mass dampers for vibration control of system under external excitation. *J Vib Cont*. 2013 Sep;**19**(12):1854-71.
21. Agushaka JO, Ezugwu AE, Abualigah L. Gazelle Optimization Algorithm: A novel nature-inspired metaheuristic optimizer. *Neural Comput Appl*. 2023 Feb;**35**(5):4099-131.
22. Holland JH. Genetic algorithms. *Scientific american*. 1992 Jul 1;**267**(1):66-73.
23. Kennedy J, Eberhart R. Particle swarm optimization. In *Proceedings of ICNN'95-international conference on neural networks, IEEE*, 1995;**27**(4):1942-48.
24. Geem ZW, Kim JH, Loganathan GV. A new heuristic optimization algorithm: harmony search. *Simulation*. 2001 Feb;**76**(2):60-8.
25. Hatamlou A. Black hole: A new heuristic optimization approach for data clustering. *Inform Sci*. 2013 Feb 10;**222**:175-84.
26. Saremi S, Mirjalili S, Lewis A. Biogeography-based optimisation with chaos. *Neural Comput Appl*. 2014 Oct;**25**:1077-97.
27. Iran Building & Housing Research Center, Minimum design loads for structures, in, 2020.
28. Iran Building & Housing Research Center, Iranian Code of Practice for Seismic Resistant Design of Buildings, Standard No. 2800, 4th Edition, in, 2020.
29. Iran Building & Housing Research Center, Seismic Provisions for Structural Concrete Buildings, Part 09, in, 2020.
30. Kaveh A., & Ardebili SR. A comparative study of the optimum tuned mass damper for high-rise structures considering soil-structure interaction, *Period Polytech Civil Eng*; 2021: **65**(4), 1036-49
31. Kaveh A., Kalateh-Ahani M. & Fahimi-Farzam M, Constructability optimal design of reinforced concrete retaining walls using a multi-objective genetic algorithm, *Struct Eng Mech*; 2013: **47**(2), 227-45.
32. Kaveh A, Fahimi Farzam, Mazyar, Maroofiaz, Rasool, (2020), Comparing H2 and H ∞ algorithms for optimum design of tuned mass dampers under near-fault and far-fault earthquake motions *Period Polytech Civil Eng*, 2020;**64**(3):904–16.
33. Ghaderi A, Nouri M, Hosseinzadeh L et al. Hybrid Vibration Control of Tall Tubular Structures via Combining Base Isolation and Mass Damper Systems Optimized by Enhanced Special Relativity Search Algorithm. *Iran J Sci Technol Trans Civ Eng*; 2024.

34. Kaveh A. *Advances in Metaheuristic Algorithms for Optimal Design of Structures*, Springer International Publishing, Switzerland, 3rd edition, 2021.
35. Kaveh A. *Applications of Metaheuristic Optimization Algorithms in Civil Engineering*, Springer, Switzerland, 2017.